

FLIGHT MEDICAL INNOVATIONS LTD.

FLIGHT-60 Turbine Ventilator

Operator's Manual



August 2022

LIT-0089 Rev.B10 OPERATING MANUAL-FLIGHT60 TURBINE SYMBOL
KEYPAD WITH OPTIONAL INTERNAL O2 MIXER SW 5.36

CE 0483

Legal Notice

Disclaimer

FLIGHT MEDICAL INNOVATIONS LTD. (FLIGHT MEDICAL) provides this Operator's Manual in its commitment to help reduce patient risk and injury. However, this manual is not intended to in any way replace or substitute duty of care to a patient, professional responsibility, or professional judgment, nor is it intended to provide any warranty, promise, guarantee, assumption of risk or duty, release, or indemnity. Physicians shall at all times maintain responsibility for patient treatment and outcomes, and FLIGHT MEDICAL further assumes no liability for patient treatment or outcome or for physician's negligence, breach of duty of care, or malpractice.

The FLIGHT-60 Ventilator operator is solely responsible for selecting the appropriate level and method of patient monitoring. Product modification or misuse can be dangerous. FLIGHT MEDICAL disclaims all liability for the consequences of product alterations or modifications, as well as for the consequences which might result from the combination of this ventilator with other products, whether supplied by FLIGHT MEDICAL or by other manufacturers, unless such a combination has been specifically endorsed by FLIGHT MEDICAL.

The design of FLIGHT-60 Ventilator, the Operator's and Service Manuals, and the labeling on the ventilator, take into consideration that the purchase and use of the equipment is restricted to trained professionals, and that certain inherent characteristics of the ventilator are known to the operator. Instructions, warnings, and caution statements are therefore limited to the specifics of the FLIGHT-60 Ventilator.



Federal law (US) restricts this device to sale by or on the order of a physician.

This Operator's Manual excludes references to various hazards which are obvious to medical professionals and operators of this equipment, to the consequences of product misuse, and to potential adverse effects in patients with abnormal conditions.

When the FLIGHT-60 Ventilator is used in homecare, hospitals, EMS and sub-acute environments, only properly trained personnel should operate the ventilator. The FLIGHT-60 Ventilator is a restricted medical device designed for use by respiratory therapists or other properly trained and qualified personnel under the direction of a physician and in accordance with applicable state laws and regulations.

Transport of patients with the FLIGHT-60 Ventilator requires that medical staff have a good working knowledge of the ventilator's use and problem resolution. Proper emergency backup equipment must be immediately available during transport.

FLIGHT-60 Ventilator operators must recognize their responsibility for implementing safety monitoring mechanisms which supply appropriate information on equipment performance and patient condition. Patient safety may be achieved through a wide variety of means, such as electronic surveillance of equipment performance and patient condition. However, equipment surveillance should not replace direct observation of clinical signs.

The liability of FLIGHT MEDICAL is subject to and limited to the exclusive terms and conditions as set forth herein. Said liability is limited whether arising out of, or related to, the manufacture and sale of goods, their installation, demonstration, sales representation, use, performance, or otherwise. Any liability based upon product warranty is limited regardless of any fault attributable to FLIGHT MEDICAL and the nature of the action (including breach of warranty, negligence, and strict liability).

The written warranties are in lieu of all other warranties, expressed or implied, including, without limitation, warranties of merchantability, fitness for any purpose, or non-infringement.

FLIGHT MEDICAL shall not be liable for any special incidental or consequential damages incurred by the buyer to a third party. The buyer shall not be entitled to make liability recoveries from FLIGHT MEDICAL due to such situations.

Warranty

The FLIGHT-60 Ventilator warranty does not apply for/ in case of:

- Defects caused by misuse, mishandling, tampering, or by modifications not authorized by FLIGHT MEDICAL or its representatives.
- Rubber and plastic components and materials, which are guaranteed to be free of defects at time of delivery.

Any product which proves during the warranty period to be defective in workmanship or material, will be replaced, credited, or repaired. FLIGHT MEDICAL retains the discretion to select the most suitable of these options. FLIGHT MEDICAL is not responsible for deterioration, wear, or abuse. In all cases, FLIGHT MEDICAL will not be liable beyond the original selling price.

Application of this warranty is subject to the following conditions:

- FLIGHT MEDICAL or its authorized representatives must be promptly notified upon detection of the defective material or equipment.
- Defective material or equipment must be returned to FLIGHT MEDICAL or its authorized representative.
- Examination by FLIGHT MEDICAL or its authorized representatives must confirm that the defect is covered by the terms of this warranty.

The above is the sole warranty provided by FLIGHT MEDICAL. No other warranty, expressed or implied, is intended. Representatives of FLIGHT MEDICAL are not authorized to modify the terms of this warranty.

In no way does this or any of FLIGHT MEDICAL's policies, training materials, guidelines, or instructions create an obligation for FLIGHT MEDICAL to perform any services.

About this Document

This document contains information intended to ensure safe and effective use of the FLIGHT-60 Ventilator.

#	Chapter Name	Contents	Page
1	Introduction	Describes the intended use of the ventilator, symbols appearing on the ventilator, and an overview of how the ventilator works.	Pg. 1-1
2	Safety Instructions	Lists WARNINGS and CAUTIONS to be adhered to, in order to safely use the ventilator.	Pg. 1-3
3	Ventilator Description	Provides a detailed description of the front, back, left, and right-side panels of the ventilator.	Pg. 3-1
4	Installation	Describes how to remove the ventilator parts from the box, mount the ventilator, plug it in, attach the patient circuit, and install the oxygen accessories.	Pg. 4-1
5	Basic Operation	Describes the basic operation of the ventilator, including how to turn the ventilator on or off, initiate ventilation, navigate between screens, set control values, cancel or accept parameter adjustments, and change parameter values.	Pg. 5-1
6	Ventilator Settings	Describes the buttons on the Home, Extended, Alarms, and Technical Screens	Pg. 6-1
7	Ventilator Alarms and Backup Ventilation	Describes the audible and visual alarm and caution signals, displays the alarm and caution specifications, provides instructions for silencing audible alarms, resetting alarms, and setting up a remote alarm	Pg. 7-1
8	Monitoring	Describes the numeric and graphic displays used for monitoring a patient's ventilation.	Pg. 8-1
9	Ventilation Modes	Describes the ventilation modes	Pg. 9-1
10	Special Functions	Describes the following special functions: nebulizer, 100% O ₂ , SIGH, manual breath, panel lock, Quick-Start, In-use O ₂ sensor calibration, Altitude Compensation.	Pg. 10-13
11	Accessories	Describes the air/oxygen entrainment mixer	Pg. 11-1
12	Cleaning and Maintenance	Describes how to clean and disinfect the ventilator parts, and how to maintain the ventilator.	Pg. 11-1
13	Troubleshooting	Describes problems that may arise, their probable cause, and possible solutions. Also includes contact information for technical support.	Pg. 13-1
14	Contact information		Pg. 14-1

#	Chapter Name	Contents	Page
15	Ventilator Quick Check Procedure	Describes the testing procedures.	Pg. 15-1
16	Technical Specifications	Describes the technical specifications for: hardware, safety, environmental and oxygen accessories.	Pg. 16-1

Table of Contents

1	INTRODUCTION	1-1
1.1	INTENDED USE	1-1
1.2	SYMBOLS	1-2
2	SAFETY INSTRUCTIONS	2-1
2.1	GENERAL WARNINGS	2-1
2.2	CAUTIONS	2-4
3	VENTILATOR DESCRIPTION	3-1
3.1	FRONT PANEL FEATURES	3-1
3.1.1	Control Buttons	3-2
3.1.2	LED Indicators	3-3
3.2	BACK PANEL FEATURES.....	3-4
3.3	LEFT SIDE PANEL FEATURES.....	3-5
3.4	RIGHT SIDE PANEL FEATURES.....	3-6
4	INSTALLATION	4-1
4.1	INTRODUCTION	4-1
4.2	REMOVING THE VENTILATOR PARTS FROM THE BOX.....	4-1
4.3	MOUNTING THE VENTILATOR	4-1
4.4	INSTALLING THE DETACHABLE AND INTEGRAL BATTERIES	4-2
4.5	PLUGGING IN THE POWER CORD (FOR AC).....	4-2
4.6	ATTACHING THE PATIENT CIRCUIT	4-3
4.7	CIRCUIT TEST	4-4
4.8	CONNECTING THE OXYGEN SUPPLY	4-5
4.8.1	Internal O ₂ Mixer.....	4-6
4.8.2	External Air/Oxygen Entrainment Mixer	4-6
4.8.3	Low-Flow Oxygen Port.....	4-9
5	BASIC OPERATION.....	5-1
5.1	POWERING ON THE VENTILATOR.....	5-1
5.2	INITIATING VENTILATION	5-2
5.3	STOPPING VENTILATION AND TURNING OFF THE VENTILATOR.....	5-2
5.4	NAVIGATING BETWEEN SCREENS	5-3
5.5	SETTING CONTROL VALUES.....	5-3
5.5.1	Default and Saved Values	5-4
6	VENTILATOR SETTINGS	6-1
6.1	HOME (PARAMETERS) SCREEN	6-1
6.1.1	Pop-Up Messages.....	6-6
6.2	EXTENDED SCREEN	6-8
6.3	ALARMS SCREEN	6-9

6.4	APNEA BACKUP SCREEN	6-11
6.5	TECHNICAL SCREEN	6-12
7	VENTILATOR ALARMS AND BACKUP VENTILATION	7-1
7.1	AUDIBLE ALARMS	7-1
7.2	VISUAL ALARMS SIGNALS	7-2
7.3	ALARM SPECIFICATIONS	7-3
7.3.1	Variable Ventilation Alarms	7-3
7.3.2	Automatic Ventilation Alarms	7-4
7.3.3	Automatic Technical Alarms	7-5
7.3.4	Low Priority	7-7
7.4	APNEA BACKUP VENTILATION	7-8
7.4.1	Apnea detection	7-8
7.4.2	Starting backup ventilation (BUV)	7-8
7.4.3	During backup ventilation (BUV)	7-8
7.4.4	Cancellation of Backup Ventilation	7-8
7.5	LOW POWER VENTILATION (LPV)	7-8
7.5.1	Cancellation of LPV Ventilation	7-9
7.6	MUTING AUDIBLE ALARMS	7-10
7.7	RESETTING ALARMS	7-10
7.8	SETTING UP A REMOTE ALARM	7-10
8	MONITORING	8-1
8.1	GRAPHIC DISPLAY	8-1
8.1.1	Waveforms and Loops	8-1
8.1.2	Trends	8-2
8.1.3	Selecting Trended Parameters	8-3
8.1.4	Time Scale Adjustment	8-3
8.2	LUNG MECHANICS MONITORING DISPLAY	8-4
8.2.1	Lung Mechanics Monitoring Display	8-4
8.3	RSBI MONITORING	8-5
8.4	ADDITIONAL MONITORING PARAMETERS DISPLAY	8-5
8.5	NUMERIC DISPLAY	8-6
9	VENTILATION MODES	9-1
9.1	ACMV MODE (ASSIST/CONTROL MANDATORY VENTILATION)	9-2
9.2	SIMV MODE (SYNCHRONIZED INTERMITTENT MANDATORY VENTILATION)	9-2
9.2.1	VCV/PCV/PRVC	9-2
9.3	SPONT MODE (SPONTANEOUS VENTILATION)	9-7
9.4	VTG (TIDAL VOLUME GUARANTEE)	9-8
9.5	MVG (MINUTE VOLUME GUARANTEE)	9-8
9.5.1	Trigger Delay	9-8
9.6	B-LEV MODE (BI-PHASIC VENTILATION)	9-9

9.7	NIV (NON-INVASIVE VENTILATION) SUB MODE	9-10
9.8	HFOT.....	9-11
10	SPECIAL FUNCTIONS	10-13
10.1	NEBULIZER (OPTIONAL)	10-13
10.2	2 MINUTES 100% O ₂ (OPTIONAL)	10-1
10.3	SIGH.....	10-1
10.4	MANUAL BREATH	10-2
10.5	PANEL LOCK	10-3
10.6	PRESET VENTILATION CONFIGURATIONS (OPTIONAL)	10-3
10.6.1	Quick-Start: Factory default settings	10-4
10.6.2	Setting and loading the preset ventilation configurations.....	10-4
10.7	IN-USE O ₂ SENSOR CALIBRATION.....	10-5
10.8	ALTITUDE COMPENSATION	10-6
11	ACCESSORIES	11-1
11.1	AIR/OXYGEN ENTRAINMENT MIXER.....	11-1
12	CLEANING AND MAINTENANCE	12-1
12.1	CLEANING AND DISINFECTING	12-1
12.1.1	FLIGHT-60 Ventilator.....	12-1
12.1.2	FLIGHT-60 Ventilator Accessories.....	12-1
12.2	MAINTENANCE	12-7
12.2.1	Preventive Maintenance	12-7
12.2.2	O ₂ Sensor Maintenance	12-8
12.2.3	Internal Battery Maintenance	12-8
12.2.4	25,000 Hour Maintenance	12-8
12.3	GENERAL WARNINGS	12-8
13	TROUBLESHOOTING.....	13-1
13.1	INTRODUCTION	13-1
13.2	ALARMS.....	13-1
13.3	GENERAL/CLINICAL.....	13-5
13.4	OXYGEN ENRICHMENT	13-9
14	CONTACT INFORMATION	14-1
15	VENTILATOR QUICK CHECK PROCEDURE	15-1
15.1	INTRODUCTION	15-1
15.1.1	Setting Up the Ventilator for the Test	15-1
15.2	QUICK CHECK PROCEDURE	15-2
15.2.1	Checking the Power Management.....	15-2
15.2.2	Checking the Alarms	15-3
15.2.3	Checking the Monitored Parameters	15-3
15.3	CHECK-OFF SHEET.....	15-4
16	TECHNICAL SPECIFICATIONS	16-1

16.1	PHYSICAL SPECIFICATIONS	16-1
16.2	PNEUMATIC SPECIFICATIONS	16-1
16.3	ELECTROMAGNETIC EMISSION - GUIDANCE AND MANUFACTURER'S DECLARATION .	16-2
16.3.1	Recommended separation distance between portable Mobile RF communications Equipment and the device	16-6
16.3.2	Recommended Separation Distances Between Power Buses and the Product	16-7
16.3.3	EMC statement of Essential Performance.....	16-7
16.4	ELECTRICAL SPECIFICATIONS.....	16-8
16.5	INTERNAL BATTERY SPECIFICATIONS	16-8
16.6	SAFETY AND PARTICULAR STANDARD SPECIFICATIONS	16-9
16.7	ENVIRONMENTAL SPECIFICATIONS	16-9
16.8	INTERNAL O2 MIXER	16-9
16.9	LOW FLOW PORT OXYGEN SPECIFICATIONS	16-10
16.10	AIR/OXYGEN ENTRAINMENT MIXER SPECIFICATIONS	16-10
16.11	INTERNAL OXYGEN SENSOR SPECIFICATIONS	16-10
16.12	WEEE DISPOSAL INFORMATION	16-11
16.13	TECHNICAL DESCRIPTION	16-12
17	INDEX.....	17-14

1 Introduction

The FLIGHT-60 Ventilator is an electrically powered, microprocessor-controlled ventilator with pressure support for spontaneous breathing. It can be pressure or time activated, volume or pressure limited, and time, pressure, or flow cycled. Backup ventilation is available, manual inflation is possible, and there is an emergency intake valve which allows the patient to pull ambient air into the patient circuit in the event of a complete loss of supply of gas pressure. Opening pressure is approximately -3 cmH₂O (-3 mbar) during emergency intake.

The FLIGHT-60 Ventilator may be powered by external power (100-240 VAC or 12.5-15 VDC) or by its Li Ion internal batteries. Two internal Li Ion rechargeable batteries power the ventilator for up to 8 hours when fully charged.

The main component of the pneumatic system is an electrically controlled pump. This pump provides a compressed gas source so that no external air compressor is needed. Additionally, the exhalation valve is activated by an electrically controlled proportional solenoid.



Transport of patients with the FLIGHT-60 Ventilator requires that medical staff have a good working knowledge of the ventilator's use and problem resolution. Proper emergency backup equipment must be immediately available during transport.

This Operator's Manual (LIT-0089) contains information intended to ensure safe and effective use of the FLIGHT-60 Ventilator.

1.1 Intended Use















The FLIGHT-60 Ventilator is intended to provide continuous or intermittent mechanical ventilation support for the care of individuals who require mechanical ventilation. Specifically, the FLIGHT-60 is applicable for adult and pediatric (i.e., infant, child and adolescent) patients who weigh at least 5 kg (11 lbs).









The FLIGHT-60 Ventilator is a restricted medical device intended for use by qualified, trained personnel under the direction of a physician; it is suitable for use in hospitals, sub-acute emergency rooms, and home care environments, as well as for transport and emergency response applications.



Flight-60 is intended for use on one patient at a time and is not intended to ventilate multiple patients at once.

1.2 Symbols

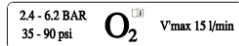
Symbol	Description
Front Panel	
	On/Off
	Alarm Reset
	Alarm off*
	OK (Enter)
	Decrease Button
	Increase Button
	Cancel
	Panel Lock
	Manual Breath
	Parameters Screen
	Extended Screen
	Technical Screen
	Nebulizer Port (optional)
Rear Panel	
	Caution; consult accompanying documents
	Type BF applied part

Symbol	Description
	Temperature limitation
	Humidity limitation
	Atmospheric pressure limitation
	DC – Direct Current
	AC – Alternating Current
	USB – Universal Serial Bus
	LAN – Local Area Network
	High Pressure (optional) and Low-Flow Oxygen Port
	MR unsafe – keep away from magnetic resonance imaging (MRI) equipment
	EU Waste Electrical and Electronic Equipment (WEEE)
HFOT	High Flow Oxygen Therapy

* "Alarm off" signal will appear if at least one alarm is off. In order to check which alarms are off the operator needs to enter the alarms screen.

2 Safety Instructions

At all times, strictly follow this manual. The safe use of the FLIGHT-60 Ventilator requires full understanding of its operation, and adherence to the manual's instructions. The equipment is only to be used for the purpose specified in Section 1.1. Observe all of the WARNINGS and CAUTIONS posted in this manual, and on buttons found on the FLIGHT-60 Ventilator and associated accessories.

2.1 General Warnings



External power connection: To maintain grounding integrity when using AC power, only connect to hospital grade receptacles. Always disconnect the external power supply prior to servicing. There is a risk of explosion if used in the presence of flammable anesthetics.



All settings and adjustments in the different ventilation modes must be made in accordance with a physician's prescribed therapy.



Do not use electrically conductive patient circuits.



Always use a clean, disinfected patient circuit.



Always use an outlet filter or equivalent at the Airway Pressure Connector, to protect the internal transducers from moisture and other contaminants.



Always use appropriate monitors to ensure sufficient oxygenation and ventilation (such as pulse oximeter and/or capnograph) when the FLIGHT-60 Ventilator is in use on a patient.



If a fault is detected in the ventilator and its life support functions are in doubt, immediately discontinue use; use an alternative method of ventilation until the fault has been corrected, and contact your provider or FLIGHT MEDICAL immediately.



The ventilator is ready for operation only when:

- It is completely assembled.
- The Quick Check Procedure, including the Exhalation Valve Calibration has been successfully completed.

Constant attention by qualified medical personnel is recommended whenever a patient is ventilated with the FLIGHT-60 Ventilator.



Failure to identify and correct alarm violations may result in patient injury.



Ensure that the oxygen source is adequate before and during the use of the optional Air/Oxygen Entrainment Mixer.



As Li-Ion batteries are charged and discharged over time, their ability to hold a charge is decreased with use. This can shorten the length of time the ventilator can function while on battery power.



The batteries should be replaced when the batteries no longer meet the needs of the user. This depends on a number of factors including settings and usage patterns.



When the FLIGHT-60 Ventilator is used for transport applications, ensure that the internal batteries are fully charged prior to use.



When the Battery Empty alarm sounds, only a limited amount of battery power remains, and an alternate power source should be found immediately.



WARNING

Charge the batteries for a minimum of three hours before powering the ventilator from the batteries. This provides fully charged batteries.



WARNING

During storage, charge the batteries for a minimum of three hours every 30 days. This provides charged batteries.



WARNING

Always ensure that the green Ext. Power LED is illuminated after connecting the FLIGHT-60 Ventilator to an external AC or DC power source. If the LED is not illuminated, check all power connections and resolve any problems.



WARNING

Always plug the FLIGHT-60 Ventilator into an AC power supply source when not in use, to ensure best battery performance.



WARNING

The flow resistance of the air inlet filter, located on the right side of the ventilator, is likely to increase with repeated use. Ensure that the filter is changed regularly.



WARNING

Only a FLIGHT MEDICAL approved patient circuit can be used with the FLIGHT-60 Ventilator.



WARNING

For pediatric ventilation ensure that the patient circuit type is suitable for pediatrics ventilation. The FLIGHT-60 Flow Sensor's dead-space is 19cc; consider using a Flow Sensor Pediatric Adaptor to reduce dead-space when ventilating pediatric patients.



WARNING

Only a FLIGHT MEDICAL approved exhalation valve can be used with the FLIGHT-60 Ventilator



WARNING

Perform an exhalation valve calibration each time a circuit/exhalation valve is installed.



To avoid the risk of cross contamination, the disposable patient circuit and exhalation valve (single use), must be discarded in a responsible manner. The user should not clean, disinfect or sterilize the circuit or the exhalation valve element for reuse.



MR unsafe – keep away from magnetic resonance imaging (MRI) equipment.

2.2 Cautions



Only use medical grade oxygen with the high- and low-pressure ports.



Do not place liquid containers in the immediate vicinity or on top of the FLIGHT-60 Ventilator. Liquids that get into the ventilator can cause equipment malfunction and damage.



An authorized FLIGHT MEDICAL factory-trained technician must do all service or repairs performed on the FLIGHT-60 Ventilator.



Do not open the ventilator or perform service on an open unit while connected to external power.



Use standard antistatic techniques while working inside the ventilator or handling any electronic parts.



Clean all external parts of the ventilator prior to servicing.



Water in the oxygen supply can cause equipment malfunction and damage.



Batteries contain Li-Ion. Do not discard them in an incinerator or force them open. Batteries should not be disposed of with normal waste.



Review FLIGHT-60 Ventilator Operator's Manual before servicing the ventilator.



Use the tools and equipment specified in this manual to perform specific procedures.

3 Ventilator Description

3.1 Front Panel Features

The front panel contains the control buttons, visual indicators, display screen, and patient circuit connection.

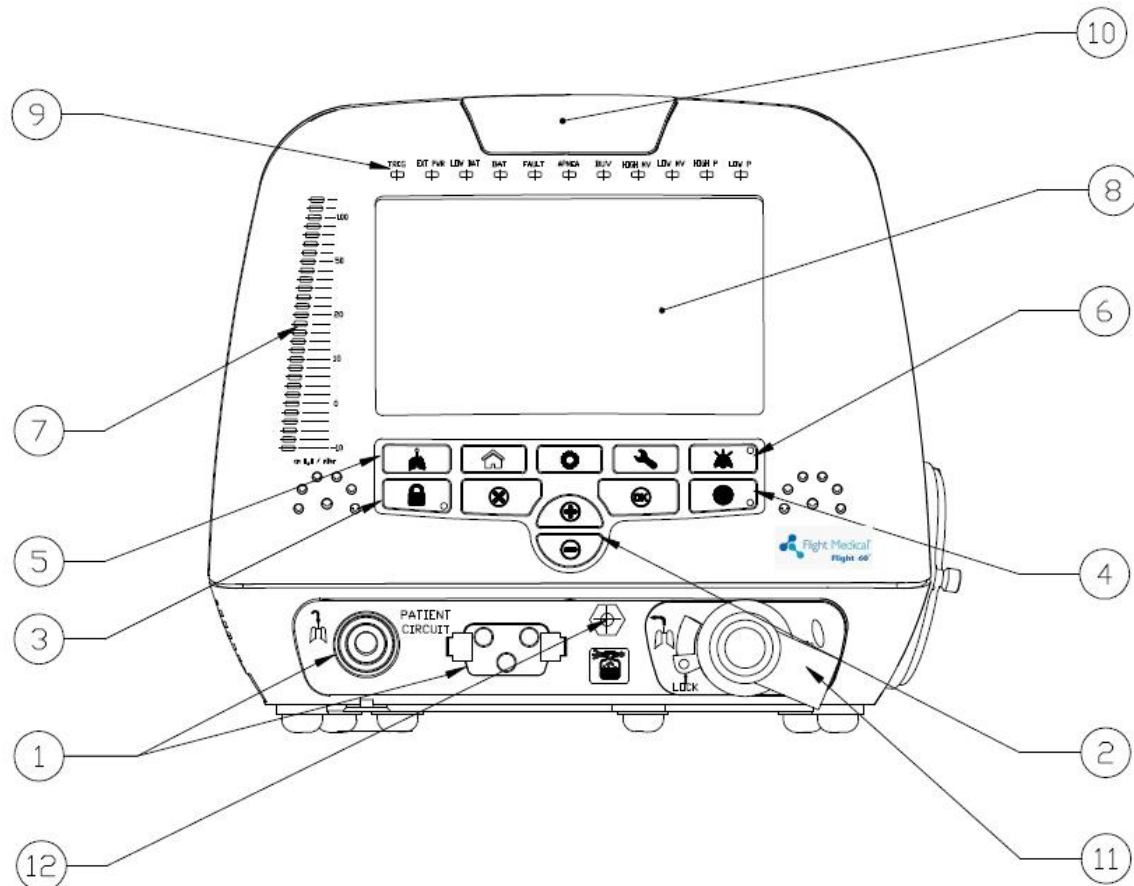

Figure 1 – Front Panel

Label	Name	Description
1	Patient Circuit Connector	Composed of a gas outlet and quick connector.
2	+/- button	Enables the user to adjust setting parameters.
3	Panel Lock button	Enables the user to lock the ventilator's control, preventing accidental changes. Pressing the button of a locked panel and then Enter, unlocks the panel.
4	On/Off button	Turns the ventilator on or off, to start or stop ventilation.
5	Manual Breath button	Delivers a user initiated manual inflation.

Label	Name	Description
6	Mute / Alarm Reset button	Toggle button. Pressing Mute temporarily mutes the audible alarm; pressing Alarm Reset clears lit alarm LEDs.
7	Pressure Gauge	The pressure gauge is a visual indicator of breath activity. The gauge always displays the airway pressure in the patient circuit. LED intensity can be controlled through the service screen.
8	Display touch screen	Enables the user to modify the ventilation, alarm, and technical settings, and to view real time patient data, alarms, battery status and logs.
9	LED Indicators	Inform the user of various events (see Section 3.1.1).
10	Primary Alarm LED	Flashes red to indicate that there is a high priority alarm.
11	Dual Limb Exhalation Valve (Optional)	Connects the patient circuit expiratory limb.
12	Nebulizer Port (optional)	Connects the pneumatic nebulizer.

3.1.1 Control Buttons

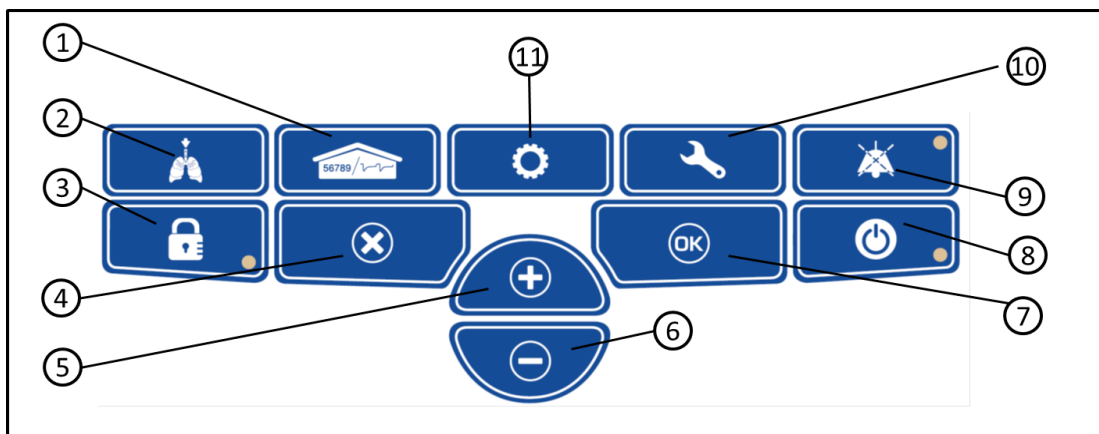









Figure 2 – Control Buttons

Item	Symbol	Description
1 – Parameters (home)		The Parameters screen is the FLIGHT-60's default screen. Display switches automatically to Parameters from the other screens if not operated for 30 seconds. Use the Parameters button to toggle between the numeric and the graphic displays.
2 - Manual Breath		Delivers a user initiated manual inflation.
3 – Panel Lock		Enables the user to lock the ventilator's control, preventing accidental changes. Pressing the button of a locked panel and then Enter, unlocks the panel.

Item	Symbol	Description
4 – Cancel		Enable the user to cancel parameters change.
5 – Increase Button		Enables the user to adjust setting parameters upwards.
6 – Decrease Button		Enables the user to adjust setting parameters downwards.
7 – OK (Enter)		Enable the user to confirm parameters or mode change.
8 – On/Off		Turns the ventilator on or off, to start or stop ventilation.
9 – Mute/Alarm Reset		The Mute/Alarm Reset mutes the audible alarm and clears lit alarm LEDs.
10 – Technical		Technical data and selection options.
11 – Extended		Additional ventilation parameters screen.

3.1.2 LED Indicators

The LED indicators on the front panel inform the user of various events. The following table describes the available LED indicators.

LED Indicator	Description
TRIG	Green LED indicates a patient's breathing effort.
EXT PWR	Green LED indicates that an external power source is being applied to the ventilator.
LOW BAT	Red LED indicates that total batteries charge level has dropped below 30%.
BAT	Orange LED indicates that the ventilator is powered on batteries.
FAULT	Red LED indicates a ventilator malfunction.
APNEA	Red LED indicates that the apnea alarm limit is being violated.
BUV	Red LED indicates that backup ventilation is active.
HIGH MV	Red LED indicates that the high minute volume alarm limit is being violated.
LOW MV	Red LED indicates that the low minute volume alarm limit is being violated.
HIGH P	Red LED indicates that the high peak airway pressure alarm limit is being violated.
LOW P	Red LED indicates that the low airway pressure alarm limit is being violated.

3.2 Back Panel Features

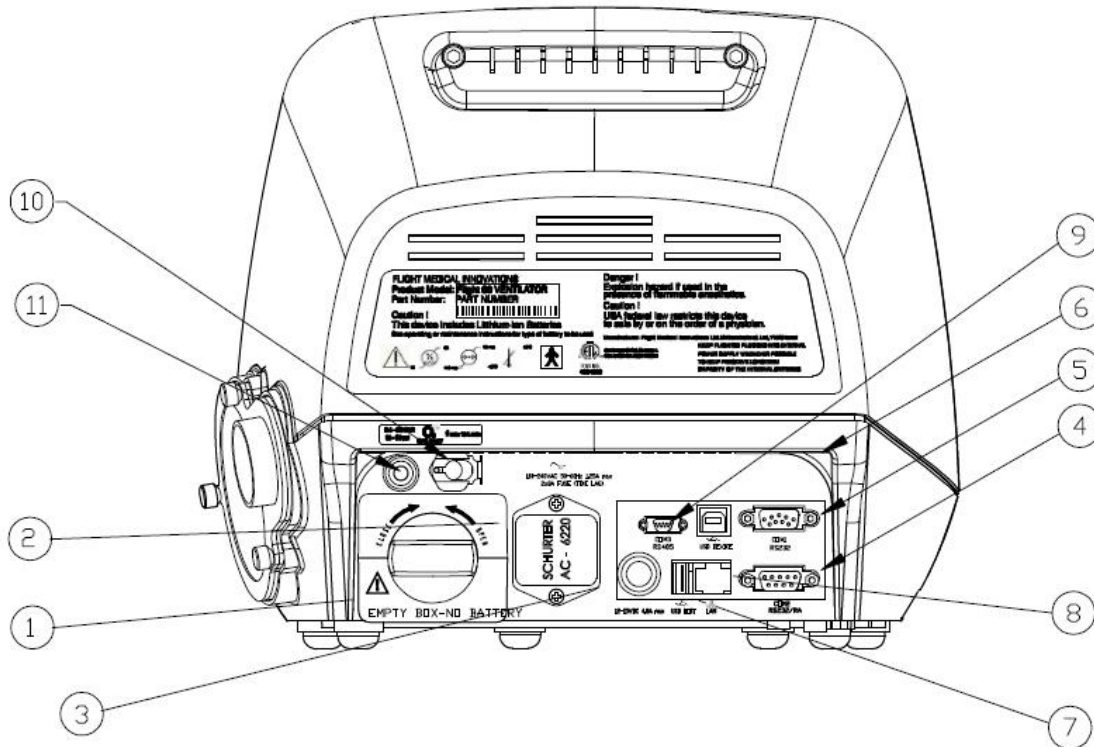

Figure 3 – Back Panel



To ensure proper grounding and prevent possible shock hazards, this device should only be connected to grounded power receptacles.



HOME CAREGIVERS: External power in the home environment must support min. 100 to max. 240 V AC, and must have a grounded receptacle.

Label	Name	Description
1	Detachable Battery	Li-Ion 14.8 VDC
2	AC Connector with Fuses	100 – 240 V AC, 50 – 60 Hz, Fuse 8A (time lag)
3	DC Connector	12.5 – 15 V DC
4	RS-232 Serial Port (COM2)	Remote alarm connector (Normally Open and Normally Closed options).

Label	Name	Description
5	RS-232 Serial Port (COM1)	Online output of events and error messages to the PC, using a dedicated PCS2 protocol; for authorized and qualified service technicians only.
6	USB B type	PC connector: USB port for downloading the main application from the PC using a dedicated PCS2 protocol; for authorized and qualified service technicians only.
7	USB A type	USB port for uploading LOG files to an external memory stick; for authorized and qualified service technicians only.
8	LAN (RJ45)	LAN for network logging (currently not available).
9	Mini RS-485 (COM3)	For connecting FLIGHT MEDICAL peripherals. For future use.
10	Low Flow Oxygen Port	Low flow oxygen enrichment source.
11	High Pressure O ₂ Port (optional)	Connects the high pressure O ₂ .

3.3 Left Side Panel Features

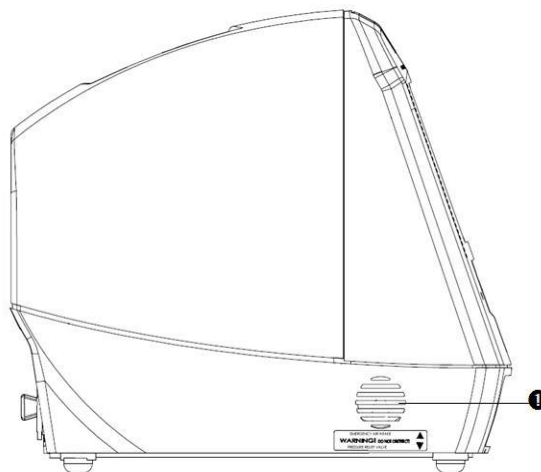

Figure 4 – Left Side Panel

Label	Name	Description
1	Emergency Air Intake	Enables the patient to pull ambient air into the patient circuit in the event of a complete system failure. The Air Intake opening pressure is approximately -3 cmH ₂ O (-3 mbar).



Do not obstruct the Emergency Air Intake! Any impediment can result in patient suffocation.



HOME CAREGIVERS: Should a complete failure of the ventilator occur, the Emergency Air Intake allows the patient to breathe from room air through the intake valve. Blockage of the valve can result in suffocation.

3.4 Right Side Panel Features

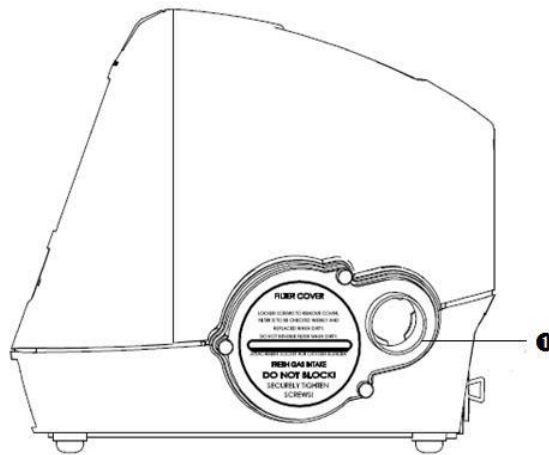

Figure 5 – Right Side Panel

Label	Name	Description
1	Fresh Gas Intake and Filter Cover	Environmental air enters through this 30 mm ID Fresh Gas Intake. The air inlet particle filter is placed behind the Filter Cover to protect the patient as well as the ventilator’s piston system from dirt and particles. The Fresh Gas Intake also serves as the attachment socket for the optional FLIGHT-60 Ventilator Air/Oxygen Entrainment Mixer.



Do not block the Fresh Gas Intake.

4 Installation

4.1 Introduction

Familiarize yourself with the instructions in this section prior to installing the ventilator. Following all of the listed steps is essential for ensuring the safest possible operation of the ventilator. Use the information in this section in conjunction with established hospital protocols and homecare dealer instructions.



Only properly trained personnel should install the ventilator.

4.2 Removing the Ventilator Parts from the Box

Before installing the ventilator, familiarize yourself with the various components. Remove all of the items from the shipping box and inspect each part and component for completeness and verify that there is no shipping damage..

The complete assembly consists of the following parts:

- FLIGHT-60 Ventilator
- AC Power Cord
- Patient Circuit – Single Patient Use
- Air Inlet Filter (pk. Of five filters)
- Detachable Battery (Main)
- Integral Battery (Secondary)

4.3 Mounting the Ventilator

→ *To mount the ventilator:*

1. Mount the ventilator on a stable surface (e.g., bedside table or the Roll Stand Assembly).
2. To mount the ventilator on the Roll Stand Assembly, follow the instructions provided with the assembly; position the ventilator on a pedestal mount and then secure it using the screws provided.

4.4 Installing the Detachable and Integral Batteries

➔ *To install the detachable battery:*

1. Insert the detachable battery into the ventilator.
2. Turn the lock dial clockwise, in the direction of the CLOSE arrow, until it is firmly locked.



Figure 6 – Installing the Detachable Battery

➔ *To install the integral battery:*

1. Insert the integral battery into the ventilator (bottom panel).
2. Attached the plastic integral battery cover and tightened the 4 screws with a Philips screw driver.

4.5 Plugging in the Power Cord (for AC)

➔ *To plug in the power cord:*

1. Plug the AC power cord into the power entry connector.
2. Plug the ventilator's electric cord into a properly grounded outlet.

The ventilator is now in STANDBY mode. The EXT PWR LED is illuminated, and the batteries begin recharging.



Figure 7 – Plugging in the Power Cord

4.6 Attaching the Patient Circuit

The following procedure describes how to attach a patient circuit to the ventilator.

➔ *To attach the single limb patient circuit:*

1. Attach the quick connector to its socket on the front panel and tightly secure.
2. Attach the 22 mm ID patient circuit to the Gas Output on the front panel.
3. If using with an HME, attach the HME to the flow orifice.



Figure 8 – Patient Circuit (Quick Connector)



Figure 9 – Patient Circuit (22 mm Tube)

➔ *To attach the dual limb patient circuit:*

1. Attach the quick connector to its socket on the front panel and tightly secure.
2. Attach the 22 mm ID inspiratory limb to the Gas Output on the front panel.
3. If using with an HME, attach the HME to the flow orifice.
4. Place the exhalation valve diaphragm inside the exhalation valve base with its holding tip facing forward.
5. Press the exhalation valve cover to its base. Rotate the exhalation valve cover 1/4 turn clockwise to secure it into place. Verify the secure pin in place.
6. Attach the 22 mm ID expiratory limb to the exhalation valve on the front panel.
7. To detach the exhalation valve cover, press the pin and rotate the exhalation valve cover 1/4 turn counter clockwise.

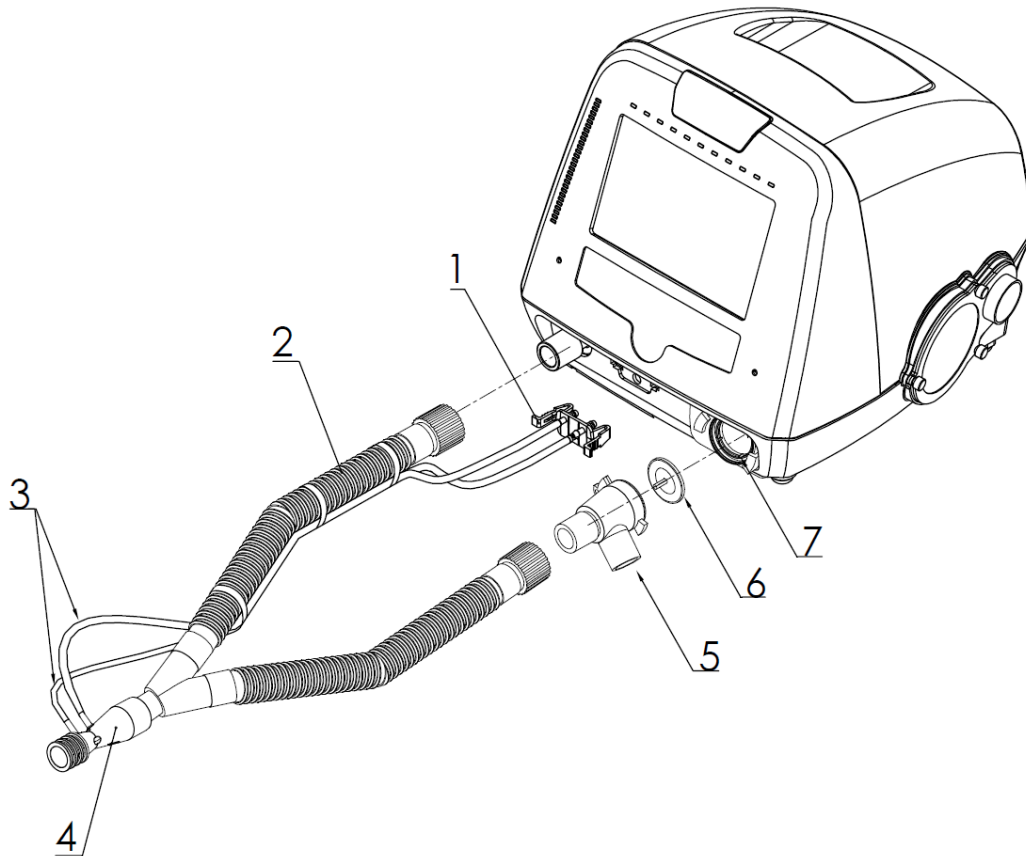

Figure 10 – Dual Limb Patient Circuit

1. Quick Connector
2. Inspiratory Limb
3. Flow Transducer Lines
4. Flow Orifice
5. Exhalation Valve Cover
6. Exhalation Valve Diaphragm
7. Exhalation Valve Base

4.7 Circuit Test



Some disposable patient circuit/exhalation valve assemblies are not compatible with the FLIGHT-60 Ventilator due to the requirements of the ventilator's pressure management system. If your disposable circuit fails consistently, switch to a FLIGHT MEDICAL approved patient circuit to ensure that the FLIGHT-60 Ventilator performs to specification.



Inadequate ventilation may result if the exhalation valve is not calibrated properly. If the circuit/exhalation valve fails the calibration procedure, try another circuit/exhalation valve or use an alternate method of ventilation.

A Circuit Test is to be performed each time a Patient Circuit or components of a Patient Circuit are replaced.

➔ *To perform a circuit test:*

1. Connect an adult (500 ml) test lung with a 90 degree elbow to the Flow Sensor's patient side or to the HME, if used.
2. Press the **On/Off** button once to place the FLIGHT-60 into standby mode (the FLIGHT-60 displays are on, but ventilation has not been initiated).
3. Press the **Technical** button once, and then tap the Circuit TEST button.
4. Press **Enter** and follow the instructions on the display.

If the test was completed successfully, "Test PASSED" is displayed.

If the test failed, "Test Failed" is displayed. Check the Patient Circuit and test the lung's connections and check for possible leaks or replace the Patient Circuit and/or test lung as needed and retest.

5. When the Circuit Test is completed, remove the test lung and press **Enter** or **Cancel** to exit.
6. Press the **Parameters** (home) button to review the various control settings.

4.8 Connecting the Oxygen Supply

Oxygen enrichment can come from high- or low-pressure source with the following options:

- Internal O₂ Mixer
- External Air/Oxygen Entrainment Mixer
- Low Flow Oxygen connector



Ensure that the oxygen source is not empty before and during oxygen enrichment.

4.8.1 Internal O₂ Mixer

Use the high pressure hose to connect the ventilator to a high pressure source. Attach the hose to the High Pressure O₂ Port located at the rear panel of the ventilator.

Feature	Specification
Connector Type	DISS
Input Pressure – Oxygen	35-90 psig/240-620 kPa
FiO ₂	21% to 100%
Accuracy	±5%
21% to 90% FiO ₂ Response Time	Up to 20 seconds

4.8.2 External Air/Oxygen Entrainment Mixer

An optional Air/Oxygen Entrainment Mixer (p/n V13-00010-60) is designed for use with the FLIGHT-60 Ventilator. It is used to blend atmospheric air with pressurized medical grade oxygen at a precise ratio. The standard oxygen inlet connection is DISS 1240.

The Air/Oxygen Entrainment Mixer specifications are described in the following table.

Feature	Specification
Flow Range	Up to 100 L/min
Input Pressure – Oxygen	35-90 psig/240-620 kPa
FiO ₂	21% to 100%
Accuracy	±8% (at flows: 10-100 L/min)



The oxygen concentration to the patient should be monitored. Set the FiO₂ alarm limit to ±10% from the set oxygen concentration. Perform O₂ sensor calibration after replacing the sensor.



The Air/Oxygen Entrainment Mixer is designed to operate with a hospital grade O₂ supply.



The volume and peep accuracies may change in some ventilations sets using Air/Oxygen Entrainment Mixer.

Accuracies using O₂ entrainment mixer :
 Peep: ± 2 ;
 Vt: $\pm 15\%$ for Vt > 300 ml and $\pm 20\%$ for Vt < 300ml;
 Set the volume and peep alarms limit.



The Maximum flow that can be reached using the external oxygen mixer is 150 LPM.



The trigger sensitivity can be changed while external oxygen mixer is used.
 Set the trigger to be comfort to the patient, without auto triggering.



No oxygen is delivered through the Air/Oxygen Entrainment Mixer while the FLIGHT-60 Ventilator is in Standby or Settings mode.



Figure 11 – Air/Oxygen Entrainment Mixer

4.8.2.1 Installing the Air/Oxygen Entrainment Mixer

The Air/Oxygen Entrainment Mixer attaches into the inlet port on the Filter Cover, located on the right side of the ventilator.



Make sure to monitor the state of the air inlet filter, and when necessary replace it to ensure that it is clean when using the Mixer.



Before attaching the Air/Oxygen Entrainment Mixer, make sure that the three hold-down screws on the Filter Cover are tight. If the screws are not tight, ambient air may enter the FLIGHT-60 Ventilator from around the inlet cover. This may change the oxygen enrichment level delivered to the patient when the Mixer is in use.

➔ *To Install the Air/Oxygen Entrainment Mixer:*

1. Unscrew the three thumb screws on the Filter Cover from the ventilator housing.
2. Remove the Filter Cover and inspect the filter. Replace the filter, if it is dirty.
3. Reattach the Filter Cover, ensuring that the three thumb screws are tight.



Figure 12 – Inspect Filter

4. With the oxygen hose facing toward the front of the ventilator, press the 30 mm OD outlet of the Mixer into the Attachment Socket (Fresh Gas Intake port) of the FLIGHT-60 Ventilator Filter Cover. Rotate the mixer 1/4 turn clockwise to secure it into place.
5. Connect the oxygen hose DISS fitting to the oxygen supply and secure the fitting.
6. Open the supply pressure valve slowly and listen to verify that there is no hiss, indicative of a leak. Do not use the oxygen mixer with a leak in the system.
7. Set the entrainment mixer dial to the desired concentration.



Ensure that the oxygen supply is enabled prior to powering on the FLIGHT-60 Ventilator and after the Air/Oxygen Entrainment Mixer is secured in place. Otherwise, stress to the internal pump will occur and gas delivery to the patient will be compromised.



Figure 13 – Air/Oxygen Entrainment Mixer Installation

4.8.3 Low-Flow Oxygen Port

When using low-flow oxygen, connect the oxygen source to the built in low pressure (low flow) oxygen port using the Oxygen Hose Connector provided with the device.



Figure 14 – Low-Flow Oxygen Port

Changes in the pressure within the patient circuit may cause oxygen concentration to vary. Actual oxygen concentration varies with changes in flow in the patient circuit. The following control parameters may impact the oxygen concentration:

- Volume or Pressure settings
- PEEP settings
- Frequency settings
- Peak Inspiratory Flow
- Flow Waveform
- I:E Ratio
- Leak Rate
- Low Pressure Oxygen Flow Rate



When oxygen is administered with a low flow source the actual delivered oxygen concentration will vary. Substantial leaks may reduce the inspired oxygen concentration. FiO_2 should be monitored and appropriate alarm settings should be used.



The oxygen flow into the ventilator must not exceed 15 Liters Per Minute (LPM) and pressure must be below 50 psig.

5 Basic Operation

Familiarize yourself with the instructions in this section prior to ventilating patients with the FLIGHT-60 Ventilator. Following all of the listed steps is essential for ensuring the safest possible operation of the ventilator. Use the information in this section in conjunction with established hospital protocols and homecare dealer instructions.



Only properly trained personnel should operate the ventilator. The FLIGHT-60 Ventilator is a restricted medical device designed for use by Respiratory Therapists or other properly trained and qualified personnel under the direction of a physician and in accordance with applicable state laws and regulations.

5.1 Powering On the Ventilator



Review all of the General Warnings and Cautions in Chapter 2 prior to using the ventilator.

The FLIGHT-60 Ventilator can be used either with an AC (external) or DC (internal batteries) power source.



Before using the ventilator, **either with AC or DC** power source, ensure that the internal batteries are fully charged.

➔ *To turn on the ventilator:*

1. Press the **On/Off** button.

The ventilator performs a brief self-test to ensure proper microprocessor function. During the self-test, verify that all indicator LEDs illuminate.

The display activates and the ventilator purges, to clean the set of flow transducer tubes and the flow orifice while alarm buzzer emits a single beep.

Following the self-test, the ventilator enters SETTINGS mode; in this mode, all settings are available and the display screen is activated. In SETTINGS mode, you can adjust the ventilation parameters; however, the FLIGHT-60 Ventilator does not ventilate and the ON indicator does not illuminate.

5.2 Initiating Ventilation

After setting all the required parameters, checking all alarm limit and control settings to ensure that they are appropriate for the patient to be ventilated, and performing exhalation valve calibration, you can initiate ventilation.

➔ *To begin ventilation:*

1. On the ventilator front panel, press the **On/Off** button for two seconds.
A "STARTING VENTILATION" message indicates the button press.
The system purges the flow transducer tubes and orifice (a purging noise is emitted) and starts ventilating. The On/Off button LED is illuminated in Green to indicate that the system is working.
2. Connect the ventilator patient circuit to the patient interface.
3. Reassess HIGH Pressure and LOW Pressure alarm settings, and adjust them to appropriate levels.
4. Verify that the TRIG indicator blinks each time the patient initiates a spontaneous inspiratory effort. Readjust P_{trig} or F_{trig} as necessary.
5. Reassess the HIGH MV and LOW MV alarms settings and adjust to the appropriate levels.

5.3 Stopping Ventilation and turning Off the ventilator

1. During ventilation, on the ventilator front panel, press the On/Off button.
The system pops up a message: "To stop ventilation, press ON/OFF key for 2 seconds".
The On/Off button LED blinks to indicate another 2-second press is expected.
2. Press the On/Off button for two seconds, within five seconds of receiving the pop-up message.
A "Stopping ventilation" message indicates the second button press. The Ventilator stop the ventilation.



When stopping ventilation all alarms are reset

➔ *To shut down the ventilator:*

During setting mode, press SHUT DOWN button. After a 5 seconds countdown, the f60 ventilator will shut down. Shut down can be canceled during the countdown.



The ventilator can be turned off only from the setting mode. If the ventilator ventilating, you must stop ventilation and then proceed to shut down.



When operating with a battery and turning off the ventilator from SETTINGS mode, Press the Mute button to mute the audible alarm.

5.4 Navigating Between Screens

Navigation between screens is performed using the keypad buttons: **Parameters**, **Extended**, and **Technical**.



Ventilation can be turned On and Off from the Parameters screen only.

The following message is displayed while in the Extended or Technical screens:

" To start ventilation press HOME (PARAMETERS) key to review your settings"

5.5 Setting Control Values

Each of the three screens (Parameters, Extended, and Technical) has a set of control buttons. You can adjust the values of the control buttons in any of the three screens in a similar fashion.

➔ *To adjust numeric control values:*

1. Select the parameter by pressing the relevant control button (for example: Rate, Ti, or P_{trig}).

The control button's color changes from grey to orange, indicating that its value is enabling for adjustment.

2. Adjust the numeric value using the **+/-** buttons.
3. Accept the value by doing one of the following:
 - a. Press the selected button again (restores the button's color to grey).
 - b. Press the **OK** (Enter) button.



Pressing another control button or letting five seconds pass without making a change will cancel the parameter change

→ *To adjust non-numeric control values:*

1. Select the parameter by pressing the relevant control button (for example: mode selection button).

The control button's color changes from grey to orange, indicating that its value is enabling for adjustment.

2. Tap the screen to toggle the value.
3. Press the **OK** (Enter) button to accept the value.



Pressing another control button or letting five seconds pass without making a change will cancel the parameter change

5.5.1 Default and Saved Values

When the device is brought up for the first time, it uses a set of default values for all of its parameters and settings. After changing the settings, the new values are saved in the system's nonvolatile memory for further usage. The newly set values persist until the device is reset (by a certified technician only); this means that stopping the device, turning it off, or disconnecting it from all power sources does not affect the parameter values.

6 Ventilator Settings

6.1 Home (Parameters) Screen

This is the default screen in standby and ventilation mode. The display always switches back automatically to Parameters from the Extended or Technical settings display. Pressing the Parameters button switches over to the main settings screen.

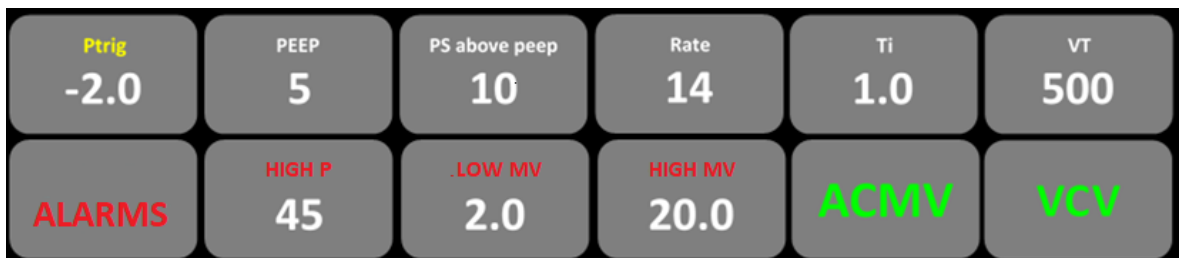

Figure 15 – Parameters Settings

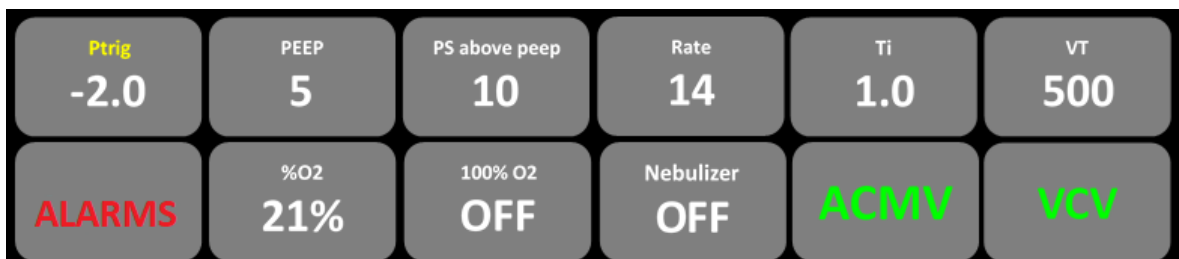















Figure 16 – Parameters Settings, Internal mixer (optional)

Button	Description
MODE	Used to choose ventilation operation mode. Options: ACMV/SIMV/SPONT/VtG/MVG/B-LEV/HFOT
CONTROL TYPE	Used to choose breath control type. Options: VCV/PCV/PRVC

Button	Description
Rate	<p>Used to set the frequency of breaths. In ACMV mode, it determines the number of time-triggered breaths; in SIMV mode, it determines the total number of mandatory breaths.</p> <p>If the selected <i>Rate</i> setting results in an inverse I:E Ratio, the system displays an "Inverse I:E" message in the Message popup window. After this warning message, the user can continue increasing the <i>rate</i> value up to an I:E Ratio of 3:1.</p> <p>Range: 1 to 99 b/min</p> <p>Resolution: 1 b/min</p>
Flow	<p>Used to set the mandatory flow (volume control).</p> <p>This control button appears only if Flow is selected in the Ti/Flow control button on the TECHNICAL screen. Otherwise, the Ti button appears (see below).</p> <p>The Flow and Ti values are related. Therefore, if the Ti setting causes the flow rate to reach the maximum or minimum level of the flow specification, the user cannot further change the Ti numeric value, and a setting limitation message appears in a popup window.</p> <div data-bbox="363 864 1353 994" style="border: 1px dashed gray; padding: 5px;">  <p>The flow can be adjusted indirectly by changing the tidal volume (Volume Control) or Ti settings.</p> </div> <p>Range: 6 to 100 L/min</p> <p>Resolution: 1 L/min</p>
Ti	<p>Used to set the inspiratory time for mandatory breaths (volume or pressure control).</p> <p>This control button appears only if Ti is selected in the Ti/Flow control button on the TECHNICAL screen. Otherwise, the FLOW button appears (see button).</p> <p>If the selected Ti setting results in an inverse I:E Ratio, the system displays an "Inverse I:E" message in the Message popup window. After this warning message, the user can continue increasing the Ti value up to an I:E Ratio of 3:1.</p> <p>If the Ti setting causes the flow rate to reach the maximum or minimum level of the flow specification, the user cannot further adjust the Ti numeric value, and a setting limitation message appears in a popup window.</p> <p>The Flow and Ti values are related. Therefore, if the Ti setting causes the flow rate to reach the maximum or minimum level of the flow specification, the user cannot further change the Ti numeric value, and a setting limitation message appears in a popup window.</p> <p>Range: 0.1 to 3.0 seconds</p> <p>Resolution: 0.1 seconds</p>

Button	Description
PEEP	Used to establish a baseline positive airway pressure in the patient circuit during the exhalation phase.
	Rapid decrease of the PEEP value may cause HIGH PBASE alarm.
	Range: 0, 3 to 40 cmH ₂ O/mbar
	Resolution: 1 cmH ₂ O/mbar
	The value of PEEP plus PC above peep cannot exceed 80 cmH ₂ O/mbar.
	The value of PEEP plus PS above peep cannot exceed 60 cmH ₂ O/mbar.
Ptrig	
	The Flight-60 provides pressure or flow based triggering.
	Used to determine the pressure trigger level (trigger sensitivity) in terms of how far the airway pressure must drop below the set baseline pressure in order for a patient's spontaneous efforts to be detected. The TRIG LED indicator illuminates each time the airway pressure reaches the set Ptrig level. The blinking TRIG LED is referred to as the Patient Effort Indicator.
	Range: -0.1 to -20 cmH ₂ O/mbar
	Resolution: 0.1 cmH ₂ O/mbar
	It is recommended to set Ptrig as close to -0.1 cmH ₂ O as possible without auto triggering, in order to maximize triggering synchrony.
Ftrig	
	The Flight-60 provides pressure or flow based triggering.
	Used to determine the patient's inspiratory flow that triggers the ventilator to deliver a breath. The TRIG LED indicator illuminates when a patient's respiratory effort is detected.
	Range: OFF, 1 to 20 LPM
	Resolution: 1 LPM

Button	Description
PS above PEEP	<p>Used to determine the level of support in pressure during inspiration, for patient triggered spontaneous breaths in SIMV, SPONT, VtG, MVG and B-LEVEL modes. During each spontaneous breath, the ventilator supports the patient by elevating the airway pressure to the PSV above peep + PEEP level.</p> <p>Breaths are terminated when any of the following conditions exists:</p> <ul style="list-style-type: none"> ■ The flow to the patient drops to the set % of that breath's peak flow. ■ The target airway pressure is exceeded by 3 cmH₂O (mbar). ■ The PSV Ti has elapsed. <p>Maximum airway pressure never exceeds the High Pressure alarm limit setting.</p> <p>Range: 0 to 60 cmH₂O/mbar</p> <p>Resolution: 1 cmH₂O/mbar</p> <div data-bbox="363 757 1353 891" style="border: 1px dashed gray; padding: 5px;">  <p>The value of PEEP plus PS above PEEP cannot exceed 60 cmH₂O/mbar.</p> </div>
VT	<p>Used to set the mandatory tidal volume for the VCV and PRVC sub-modes.</p> <p>Range: 30 to 2,200 ml</p> <p>Resolution: 10 ml</p>
PC above PEEP	<p>Used to set the target pressure for the PCV sub-mode.</p> <p>Range: 5 to 80 cmH₂O/mbar</p> <p>Resolution: 1 cmH₂O/mbar</p> <div data-bbox="363 1196 1353 1330" style="border: 1px dashed gray; padding: 5px;">  <p>The value of PEEP plus PC above PEEP cannot exceed 80 cmH₂O/mbar.</p> </div>
PS min	<p>Used to set the minimal pressure that can be applied in VtG and MVG modes.</p> <p>Range: 5 to 60 cmH₂O/mbar</p> <p>Resolution: 1 cmH₂O/mbar</p> <div data-bbox="363 1464 1353 1599" style="border: 1px dashed gray; padding: 5px;">  <p>The value of PEEP plus PS min cannot exceed 60 cmH₂O/mbar.</p> </div>
PS max	<p>Used to set the maximal pressure that can be applied in VtG and MVG modes.</p> <p>Range: 5 to 60 cmH₂O/mbar</p> <p>Resolution: 1 cmH₂O/mbar</p> <div data-bbox="363 1733 1353 1868" style="border: 1px dashed gray; padding: 5px;">  <p>The value of PEEP plus PS max cannot exceed 60 cmH₂O/mbar.</p> </div>

Button	Description
P Low	Used to set the low pressure baseline in B-LEV mode. Range: 0 to 40 cmH ₂ O/mbar Resolution: 1 cmH ₂ O/mbar
	 <p>The value of P Low plus PS above PEEP cannot exceed 60 cmH₂O/mbar. The value of P Low cannot exceed the P High value.</p>
P High	Used to set the high pressure baseline in B-LEV mode. Range: 3 to 60 cmH ₂ O/mbar Resolution: 1 cmH ₂ O/mbar
	 <p>The value of P High plus PS above PEEP cannot exceed 60 cmH₂O/mbar.</p>
T Low	Used to set the low pressure baseline period in B-LEV mode. Range: 0.5 – 5.0 seconds Resolution: 0.1 second
T High	Used to set the high pressure baseline period in B-LEV mode. Range: 1 – 15.0 seconds Resolution: 0.5 second
HFOT Flow (optional)	Used to set the target flow during in HFOT mode. Range: 10 – 60 L/min Resolution: 1 L/min
%O₂ (optional)	Used to set O ₂ enrichment level. Range: 21 to 100% Resolution: 1%
100% O₂ (optional)	ON/OFF – Used to activate 2 minutes of 100% O ₂ enrichment.
Nebulizer (optional)	Used to activate the synchronized nebulizer function. Range: ON/OFF
	 <p>Nebulization time is determined by the Nebulizer Period control button located in the Technical screen</p>
HIGH P	Used to set the maximum allowed pressure value of a breath. Range: LOW P to 99 cmH ₂ O/mbar Resolution: 1 cmH ₂ O/mbar
LOW MV	Used to set the minimum Minute Volume allowed for a patient. Range: 0.1 to High MV – 1 Resolution: 0.1 L

Button	Description
HIGH MV	Used to set the maximum Minute Volume allowed for a patient. Range: Low MV + 1.0 to 50 Resolution: 0.1 L
ALARMS	Used to open the Alarms Screen

6.1.1 Pop-Up Messages

The following table lists the pop-up messages, and how they are activated.

Message	Reason
PEEP is limited by PC	PEEP reached 80 – PC
PC is limited by PEEP	PC reached 80 - PEEP
PEEP is limited by PS	PEEP reached 60 – PS During SPONT mode: if PS=0 → PEEP>=3
PS is limited by PEEP	PSV reached 60 – PEEP During SPONT mode: if Peep =0 → PS>=5
PEEP is limited by High P	PEEP reached High P - 3
High P is limited by PEEP	High P reached PEEP + 3
PEEP is limited by PS max	In VG mode only: PEEP reached 60 – PS max
PS MAX is limited by PEEP	In VG mode only: PS max reached PEEP
PS is limited by P LOW	In B-Lev mode only: PS max reached 60 – P Low
P LOW is limited by PS	In B-Level mode only: P LOW reached PS
Apnea-PC is limited by PEEP	Apnea-PC reached 80-PEEP
Max I:E reached	Ti/Flow or <i>Rate</i> reached a value that caused the I:E ratio to reach its max range 3:1.
INVERSE I:E	Ti or <i>Rate</i> reached a value that inversed the I:E ratio.
LOW P is limited by HIGH P	LOW P reached HIGH P – 1
HIGH P is limited by LOW P	HIGH P reached LOW P + 1
Max Flow reached	Increasing VT or Decreasing Ti caused the Flow to reach its max possible value.
Min Flow reached	Decreasing VT or increasing Ti caused the Flow to reach its min possible value.
HIGH MV is limited by LOW MV	HIGH MV reached LOW MV + 1.
LOW MV is limited by HIGH MV	LOW MV reached HIGH MV – 1.

Message	Reason
Max Ti reached	Increasing VCV or Decreasing Flow caused Ti to reach its max possible value.
Min Ti reached	Decreasing VCV or increasing Flow caused Ti to reach its min possible value.
LOW O ₂ is limited by HIGH O ₂	LOW O ₂ reached HIGH O ₂ - 10.
HIGH O ₂ is limited by LOW O ₂	HIGH O ₂ reached LOW O ₂ + 10.
Max E:I reached	Ti and Rate yielded the maximum E:I ratio
PS MIN is limited by PS MAX	In VG mode only: PS min reached PS max
PS MAX is limited by PS MIN	In VG mode only: PS max reached PS min
P HIGH is limited by P LOW	In B-Level mode only: P HIGH reached P LOW
P LOW is limited by P HIGH	In B-Level mode only: P LOW reached P HIGH
PS is limited by P LOW	In B-Level mode only: PS reached P LOW
LOW Rate is limited by HIGH Rate	LOW Rate reached HIGH Rate
HIGH Rate is limited by LOW Rate	HIGH Rate reached LOW Rate
VG mode is not available when NIV is ON	When NIV is ON VG mode is not available
No external storage available	Logs download failure: No free space on the USB external storage
100% O ₂ mode is available only during ventilation	2 minutes 100% O ₂ function is only available when ventilating
Nebulizer cannot be activated when not ventilating	Nebulizer is only active while ventilating
Nebulizer cannot be activated due to small VT	Nebulizer is not available for smaller than 200ml volume ventilation
Nebulizer was disabled due to small VT. Activate it again!	Nebulizer is not available for smaller than 200ml volume ventilation
VT is limited when Nebulizer is ON	Nebulizer is not available for smaller than 200ml volume ventilation
O ₂ Leak Sensor calibration FAILED!	O ₂ Leak Sensor calibration failed
100% O ₂ mode is not available during O ₂ calibration	During calibration 100% O ₂ mode is not available
Cannot start O ₂ calibration when 100% O ₂ mode is ON	O ₂ calibration is not available when 100% O ₂ mode is ON
Nebulizer cannot be activated during O ₂ calibration	Nebulizer cannot be activated during O ₂ calibration

Message	Reason
Cannot start O2 calibration when nebulizer is ON	O2 calibration is not available when Nebulizer is ON
LOW MVe alarm is disabled!	When NIV is set to ON the Low MVe alarm is disabled
VT was updated due to Flow limitations	In VCV only: When the set VT do not correspond the set Ti
Cannot start Circuit Test due to low power	There is no Circuit Test in LPV mode
Settings could not be changed during LPV	Settings are disabled during LPV
Cannot change mode HFOT during ventilation	HFOT should be stopped before changing mode
HFOT is not available without O2 mixer	HFOT is not available without O2 mixer

6.2 Extended Screen

Pressing the Extended button switches over to the extended settings screen.



Figure 17 – Extended Settings

Button	Description
SIGH	ON/OFF – Used to activate SIGH sub-mode of ventilation.
Altitude Comp.	Used to select the altitude compensation. Resolution: 500-4500 m
NIV	ON/OFF – Used to active non-invasive ventilation.
Trends	ON/OFF/Clear – Used to active and clear trended data. Factory Default: OFF

Button	Description
Trigger Delay	Used to activate the MVG trigger delay function. OFF: Trigger delay function is disabled. ON: Doubles the delay time before mandatory (time cycled) ventilation is activated.
Rise Profile	Used to set the rise level that the system will deliver. Available levels are 1 (fastest) to 5 (slowest). This option is enabled only in PCV and PSV modes. <div style="border: 1px dashed gray; padding: 5px; margin-top: 10px;">  Set the initial Rise Profile to 3 and then adjust it according to the patient comfort. </div>
PSV Flow Term	Used to set the expiratory trigger from 0% to 90% of the peak flow. This option is enabled only in PSV mode. When PSV Flow Term is set to "OFF" the length of the pressure support breath is the "PSV Ti" set value.
PSV Ti	Used to control and limit the inspiratory time in Pressure Support Ventilation from 0.1 to 3 seconds.
Waveform	Used to select the type of waveform: <ul style="list-style-type: none"> ■ Square – The flow stays constant during the inspiratory phase. ■ Descend – The flow descends linearly until the final flow (at the end of inspiration) is 50% of the peak flow. (Peak flow is calculated based on the tidal volume and inspiratory time.) This option is enabled only in VCV sub mode.
Volume trigger	ON/OFF – On- The flow trigger is initiated also if a 1/100*f trig inhaled quantity of volume was detected.

6.3 Alarms Screen

Pressing the Alarms button switches over to the Alarms settings screen.



Figure 18 – Alarms Settings

Button	Description
Buzzer	Used to set the alarm buzzer volume. Available options: HIGH and LOW

Button	Description
APNEA BACKUP	Used to open the Apnea Backup Screen
LOW P	Used to set the minimum allowed pressure of a mandatory breath. Range: 1 to HIGH P Resolution: 1 cmH ₂ O/mbar
HIGH P	Used to set the maximum allowed pressure value of a mandatory breath. Range: LOW P to 99 cmH ₂ O/mbar Resolution: 1 cmH ₂ O/mbar
LOW Rate	Range: OFF, 1 to 99 bpm Resolution: 1 bpm
HIGH Rate	Range: OFF, 1 to 99 bpm Resolution: 1 bpm
LOW MV	Used to set the minimum Minute Volume allowed for a patient. Range: 0.1 to High MV – 1 Resolution: 0.1 L
HIGH MV	Used to set the maximum Minute Volume allowed for a patient. Range: Low MV + 1.0 to 50 Resolution: 0.1 L
LOW Vti	Range: OFF, 10 to 2,200ml Resolution: 10ml
LOW Vte	Range: OFF, 10 to 2,200ml Resolution: 10ml
FiO₂ Low	Used to define the low value of oxygen in the ventilator air mixture that sets off the alarm. The low value can be set to any value between OFF (min value 21%) and FiO ₂ High minus 10. Range: OFF, 22% to FiO ₂ High -10 Resolution: 1% Enabled only when FiO ₂ is activated (ON).
FiO₂ High	Used to define the high value of oxygen in the ventilator air mixture that sets off the alarm. The high value can be set to any value between FiO ₂ Low plus 10 to OFF (max value 100%). Range: FiO ₂ Low +10 to 99%, OFF Resolution: 1% Enabled only when FiO ₂ is activated (ON).
Apnea Interval	Used to set the maximum allowed time of apnea. Range: 10 to 60 seconds Resolution: 10 seconds

6.4 Apnea Backup Screen

Pressing the Apnea Backup button switches over to the Apnea Backup (BUV) settings screen.

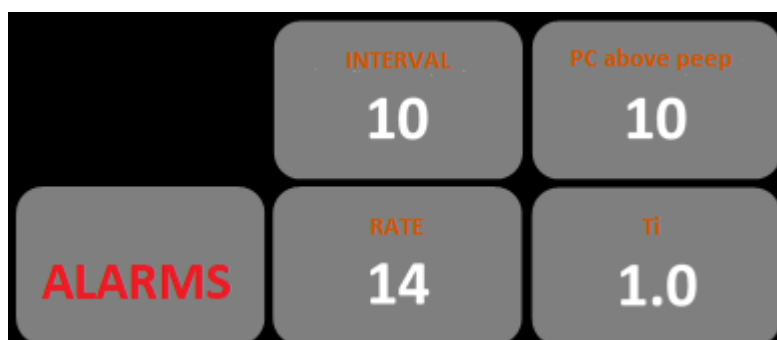



Figure 19 – Apnea Backup Settings

Button	Description
ALARMS	Used to return to the Alarms Screen
Interval	Used to set the maximum allowed time of apnea. At the end of this period backup ventilation (BUV) is starting automatically. Range: 10 to 60 seconds Resolution: 10 seconds
PC above PEEP	Used to set the target pressure for backup ventilation mode (BUV). Range: 5 to 80 cmH ₂ O/mbar Resolution: 1 cmH ₂ O/mbar <div style="border: 1px dashed gray; padding: 5px; margin-top: 10px;">  <p>The value of PEEP plus BUV PC above PEEP cannot exceed 80 cmH₂O/mbar.</p> </div>
Rate	Used to set the BUV frequency of breaths. Range: 1 to 99 Resolution: 1 b/min
Ti	Used to set the inspiratory time for BUV or pressure control breaths. Range: 0.1 to 3.0 seconds Resolution: 0.1 seconds

6.5 Technical Screen

Pressing the Technical button switches over to the technical settings screen.



Figure 20 – Technical Settings

Button	Description
FiO2 Sensor	Used to perform in-use O ₂ calibration and activate or deactivate O ₂ monitoring. Activating FiO ₂ displays the FiO ₂ value on the screen; deactivating it turns the display off.
Ti/Flow ctrl.	Used to specify whether the Inspiratory Time or the Flow criteria will stay constant during Volume Controlled management.
Nebulizer Period (optional)	Used to set the nebulization time period. Range: 5 to 60 minutes Factory Default: 5 minutes
Power Save	Used to set activate/deactivate power saving and night mode. Range: ON, OFF, Night ON: Power saving mode is turned on - screen is turned off after 5 minutes and the pressure gauge displays one LED only to indicate the peak pressure. Night: Night mode is turned on - screen and the pressure gauge are turned off after 5 minutes (no pressure gauge LED is illuminated). In both modes the screen is turned ON automatically in case of an alarm or if any key is pressed by the user.
Show Info	Used to display the following system information: Unit Serial Number, Software Version, Compressor Serial Number, Total Vent hours, Motor hour meter, and Next Service
Circuit TEST	Enabled only on Settings, disabled during ventilation. Used to enter the patient circuit exhalation valve calibration process. Calibration must be performed each time a patient circuit is replaced.

Button	Description
Maneuver	This button replaces "Circuit TEST" button during ventilation. Enabled during ventilation. ON/OFF
Set Load	Used to load a ventilation configuration that has been predefined in the ventilator.
Set Save	Used to save a ventilation configuration in the ventilator, for later use. Up to five configurations can be saved.
Set Clock	Used to set the system time and date, for logging purposes. <div data-bbox="493 712 552 772" data-label="Image"></div> <p>Both the Alarm and the Change logs must be cleared following clock set.</p>
Show Log Alarm	Used to display the alarms that have occurred, by date, time, and type. <div data-bbox="493 943 552 1003" data-label="Image"></div> <p>Alarm logs can be cleared by tapping the "Clear Log" button (passcode: 1315)</p>
Show Log Change	Used to display the changes that have been made to the ventilator states, modes, and settings. These changes are displayed by date, time, type, and values. <div data-bbox="493 1296 552 1357" data-label="Image"></div> <p>Change logs can be cleared by tapping the "Clear Log" button (passcode: 1315).</p>
SERVICE	Used to access the service menu. This function is available to authorized and qualified service technicians. Please refer to the Service Manual.

7 Ventilator Alarms and Backup Ventilation

The FLIGHT-60 Ventilator comes with an intelligent alarm system, which warns you of problems with the ventilator. An alarm occurs when there is a risk to the patient. A caution occurs when there is an undesirable situation which does not pose immediate risk to the patient.

The FLIGHT-60 Ventilator alarm system includes variable and automatic alarms (ventilation and technical).

These alarms can either be audible or visual.

This chapter describes:

- Audible Alarms (see Section 7.1)
- Visual Alarms Signals (see Section 7.2)
- Alarm Specifications of the variable and automatic alarms (see Section 7.3)
- Apnea Backup Ventilation (see Section 7.4)
- Low Power Ventilation (see section 7.5)
- Muting Audible Alarms (see section 7.6)
- Resetting Alarms (see Section 7.7)
- Setting Up a Remote Alarm (see Section 7.8)

7.1 Audible Alarms

The FLIGHT-60 alarm system has three distinguished alarm types:

- **Low Priority Alarm** - Operator awareness is required. These alarms alert you to a change in the ventilator status.
- **Medium Priority Alarm** - Requires the operator's prompt response.
- **High Priority Alarm** - Require the operator's immediate response.

Audible Indicators:

- **High Priority Alarms** - When a high priority alarm is detected a 10-beep sound is repeated. The sound continues until the alarm cause is corrected.
- **Medium Priority Alarms** - When a medium priority alarm is detected a 3-beep sound is repeated. The sound continues until the cause of the alarm is corrected.
- **Low Priority Alarm** - - When a low priority alarm is detected a 2-beeps sound in repeated. The sound continues until the cause of the alarm is corrected.



The caregiver can select the alarm sound level between high/low.

7.2 Visual Alarms Signals

The visual alarm system is composed of:

- One major visual alarm signal – Flashing red led to indicate that there are alarms in the system.

Type of flashing indication:

- **High Priority Alarms** – When a high priority alarm is detected the indicator is flickering red with high frequency and continue until the alarm cause is corrected.
 - **Medium Priority Alarms** - When a medium priority alarm is detected the indicator is flickering red with a low frequency and continue to flick until the cause of the alarm is corrected.
 - **Low Priority Alarm** - When a low priority alarm is detected the indicator is constantly red until the cause of the alarm is corrected.
- An Alarm Message display:
 - **High Priority Alarms** – Displayed in red
 - **Medium Priority Alarms** – Displayed in Yellow
 - **Low Priority Alarms**– Displayed in Yellow



If multiple alarms occur at the same time, the three most important alarms are displayed according to their internal priority, Left to right from the highest to the lowest priority. Every time a new alarm/caution is activated, the system recalculates the correct order of the alarms and displays the three most important ones

- Indicator LEDs - Few alarms are supported by red LED indicators, which are synchronized with the major visual alarm signal. They include: FAULT, APNEA, BUV, HIGH MV, LOW MV, HIGH P, and LOW P. When the alarms are active, their corresponding LEDs are flashing. When an alarm becomes passive (inactive), its corresponding LED turns stable (lit). When no other alarm is active, pressing on Mute key clears inactive alarms LEDs.



FAULT LED indicates unrecoverable internal system failure. Ventilate the patient with an alternate means of ventilation. Make note of the message in the alarm

display area and the alarm log. Contact your provider or FLIGHT MEDICAL.

7.3 Alarm Specifications

This section describes the specifications for the FLIGHT-60 Ventilator:

- Variable ventilation alarms
- Automatic ventilation alarms
- Automatic technical alarms

7.3.1 Variable Ventilation Alarms

Alarm	Priority	Range	Activation
LOW PRESSURE	High	1 to (HIGH P - 1 cmH ₂ O)	When the airway pressure remains below the low pressure alarm limit setting for three consecutive breaths
HIGH PRESSURE	Medium	3 to 99 cmH ₂ O	When the airway pressure reaches the high pressure alarm limit setting.
LOW MV EXH	High	0.1 to 50.0 L/min	When the expiratory minute volume falls below the Low Minute Volume alarm setting.
LOW MV INS	High	0.1 to 50.0 L/min	When the inspiratory minute volume falls below the Low Minute Volume alarm setting.
HIGH MV EXH	Medium	1.0 to 50.0 L/min	When the expiratory minute volume exceeds the High Minute Volume alarm setting.
HIGH MV INS	Medium	1.0 to 50.0 L/min	When the inspiratory minute volume exceeds the High Minute Volume alarm setting.
FiO ₂ LOW	Medium	OFF, 22% to 89% O ₂	When the delivered O ₂ falls below the FiO ₂ Low alarm setting.
FiO ₂ HIGH	Medium	31% to 99% O ₂	When the delivered O ₂ exceeds the FiO ₂ High alarm setting.
APNEA	Medium	10 to 60 sec	When no breaths have been delivered for a period longer than the preset apnea time of 10 to 60 seconds.
High Rate	Medium	OFF, 1 to 99	When the average respiratory rate value for five consecutive breaths exceeds the High Rate limit.

Alarm	Priority	Range	Activation
Low Rate	Medium	OFF, 1 to 99	When the total respiratory rate value is below the Low Rate limit.
Low Vte	Medium	OFF, 10 to 2,200ml	When the average exhaled tidal volume value of five consecutive breaths does not reach the low Vte alarm limit setting.
Low Vti	Medium	OFF, 10 to 2,200ml	When the average inhaled tidal volume value of five consecutive breaths does not reach the low Vte alarm limit setting.

7.3.2 Automatic Ventilation Alarms

Alarm	Priority	Activation
CHECK CIRCUIT	High	Patient circuit disconnection in three places: <ol style="list-style-type: none"> 1. Disconnection at the outlet 2. Disconnection at the exhalation limb 3. Disconnection at the patient side
BUV	High	When backup ventilation has started due to detected Apnea .
LOW PBASE	Medium	When the PEEP value is less than the set value by more than 3 cmH ₂ O for more than three seconds (depends on stable PEEP for the previous 5 consecutive breaths).
HIGH PBASE	Medium	When the PEEP value is higher than the set value by more than 8 cmH ₂ O (depends on stable PEEP for the previous 5 consecutive breaths).
PROX LINE	Medium	When possible proximal tube disconnection is detected (the outlet pressure is significantly higher than the patient pressure).
OCCLUSION	Medium	When the pressure does not drop to less than PEEP + 15 within three seconds, although the safety solenoid is open.
PC NOT REACHED	Medium	When the pressure does not reach 50% of the set level for three consecutive breaths.
VT NOT REACHED	Medium	In VtG when 70% of the set target volume cannot be achieved with the PSV max settings in 15 consecutive breathes. In PRVC when 70% of the set target volume is not reached during 10 consecutive breathes. In VCV when 70% of the set target volume is not reached during 5 consecutive breathes.
VT EXCEEDED	Medium	In VtG when VTi is over 110% of the set target volume for more than 30 consecutive breathes.

Alarm	Priority	Activation
		When VTI is more than 150% of PRVC target volume value for 10 consequent PRVC breathes.
LOW HFOT FLOW	Medium	When the flow is dropping below 50% of the target HFOT flow value for more than 5 seconds
BATTERY LOW	Medium	When the total battery's capacity is less than 30%, but more than 15%. The alarm can be reset for 15 minutes by pressing the Alarm Reset button.
EMPTY BAT	High	When the total battery's capacity is less than 15% or the integral battery capacity is less than 5%. The alarm can be reset only if both batteries are charging, or the combined capacity is greater than 15%.
O ₂ SUPPLY FAILED	High	When the oxygen pressure source < 2.4bar and %O ₂ is set above 21%. This alarm is available with the optional internal O ₂ mixer model.
CHECK FiO ₂ SENSOR	Medium	When the O ₂ sensor returns an out-of-range value, indicating that the internal sensor needs to be calibrated. This alarm is available with the optional internal O ₂ mixer model.
O ₂ LEAK DETECTED!	Medium	When the internal FiO ₂ leak sensor level is above 35%.
O ₂ SUPPLY WILL BE OFF	Medium	When the internal FiO ₂ leak sensor level is above 40%.
O ₂ SUPPLY IS OFF!	High	When the internal FiO ₂ leak sensor level is above 40% for more than 5 minutes.
CHECK O ₂ LEAK SENSOR	Medium	When the O ₂ Leak sensor value is out of range
LPV	High	See section 7.5

7.3.3 Automatic Technical Alarms



Alarm	Priority	Activation
MOTOR FAULT	High	When the motor does not work properly
POWER FAULT	High	When electrical circuit fails.
MEMORY FAULT	Medium	When the NVRAM does not work properly.
HIGH MOTOR TEMPERATURE	High	When the turbine temperature is greater than 80°C

Alarm	Priority	Activation														
Main Battery Fault	Medium	The alarm has several possible causes. The detailed cause can be found in the Logs screen.														
		<table border="1"> <thead> <tr> <th>Log text</th> <th>Activation</th> </tr> </thead> <tbody> <tr> <td>MAIN BATTERY CHARGER</td> <td>When the detachable (main) battery charger does not start working.</td> </tr> <tr> <td>HIGH</td> <td>When the detachable (main) battery voltage is higher than 18 V.</td> </tr> <tr> <td>MAIN BATTERY VOLTAGE LOW</td> <td>When the detachable (main) battery voltage is lower than 11 V.</td> </tr> <tr> <td>MAIN BATTERY TEMPERATURE HIGH</td> <td>When the detachable (main) battery temperature is higher than 60 °C.</td> </tr> <tr> <td>MAIN BATTERY GAUGE ERROR</td> <td>When there is no communication with the battery CPU.</td> </tr> <tr> <td>MAIN BATTERY VOLTAGE ERROR</td> <td>When the detachable (main) battery voltage is different than the gauge voltage.</td> </tr> </tbody> </table>	Log text	Activation	MAIN BATTERY CHARGER	When the detachable (main) battery charger does not start working.	HIGH	When the detachable (main) battery voltage is higher than 18 V.	MAIN BATTERY VOLTAGE LOW	When the detachable (main) battery voltage is lower than 11 V.	MAIN BATTERY TEMPERATURE HIGH	When the detachable (main) battery temperature is higher than 60 °C.	MAIN BATTERY GAUGE ERROR	When there is no communication with the battery CPU.	MAIN BATTERY VOLTAGE ERROR	When the detachable (main) battery voltage is different than the gauge voltage.
Log text	Activation															
MAIN BATTERY CHARGER	When the detachable (main) battery charger does not start working.															
HIGH	When the detachable (main) battery voltage is higher than 18 V.															
MAIN BATTERY VOLTAGE LOW	When the detachable (main) battery voltage is lower than 11 V.															
MAIN BATTERY TEMPERATURE HIGH	When the detachable (main) battery temperature is higher than 60 °C.															
MAIN BATTERY GAUGE ERROR	When there is no communication with the battery CPU.															
MAIN BATTERY VOLTAGE ERROR	When the detachable (main) battery voltage is different than the gauge voltage.															
SEC BAT Fault	Medium	The alarm has several possible causes. The detailed cause can be found in the Logs screen.														
		<table border="1"> <thead> <tr> <th>Log text</th> <th>Activation</th> </tr> </thead> <tbody> <tr> <td>SEC. BATTERY CHARGER FAULT</td> <td>When the integral (secondary) battery charger does not start working.</td> </tr> <tr> <td>SEC. BATTERY GAUGE ERROR</td> <td>When there is no communication with the battery CPU.</td> </tr> <tr> <td>SEC. BATTERY VOLTAGE HIGH</td> <td>When the integral (secondary) battery voltage is higher than 18 V.</td> </tr> <tr> <td>SEC. BATTERY VOLTAGE LOW</td> <td>When the integral (secondary) battery voltage is lower than 11 V.</td> </tr> <tr> <td>SEC. BAT TEMP HIGH</td> <td>When the integral (secondary) battery temperature is higher than 60 °C.</td> </tr> </tbody> </table>	Log text	Activation	SEC. BATTERY CHARGER FAULT	When the integral (secondary) battery charger does not start working.	SEC. BATTERY GAUGE ERROR	When there is no communication with the battery CPU.	SEC. BATTERY VOLTAGE HIGH	When the integral (secondary) battery voltage is higher than 18 V.	SEC. BATTERY VOLTAGE LOW	When the integral (secondary) battery voltage is lower than 11 V.	SEC. BAT TEMP HIGH	When the integral (secondary) battery temperature is higher than 60 °C.		
Log text	Activation															
SEC. BATTERY CHARGER FAULT	When the integral (secondary) battery charger does not start working.															
SEC. BATTERY GAUGE ERROR	When there is no communication with the battery CPU.															
SEC. BATTERY VOLTAGE HIGH	When the integral (secondary) battery voltage is higher than 18 V.															
SEC. BATTERY VOLTAGE LOW	When the integral (secondary) battery voltage is lower than 11 V.															
SEC. BAT TEMP HIGH	When the integral (secondary) battery temperature is higher than 60 °C.															



When an alarm message is generated, it is recorded in the alarms log with its accurate time and date.

7.3.4 Low Priority Alarms

Alarm	Activation
Power Switchover	When the device is disconnected from the AC or DC power supply and starts using the internal battery.
Battery Caution	When the total battery's capacity is less than 50%, but more than 30%. The alarm can be reset by pressing the Alarm Reset button.
Sec Battery Only!	When only the internal (secondary) battery is active.
Check O ₂ Supply	<p>When the oxygen source pressure is low during setting, before starting ventilation.</p> <div style="border: 1px dashed gray; padding: 10px; margin: 10px 0;">  <p>The alarm can be reset by pressing the Alarm Reset button.</p> </div> <p>This alarm is available with the optional internal O₂ mixer model.</p>
O ₂ Leak	<p>When the internal FiO₂ leak sensor level is above 27%. Caution can be reset by pressing the Alarm Reset button.</p> <div style="border: 1px dashed gray; padding: 10px; margin: 10px 0;">  <p>Pressing the Alarm Reset button for 2 seconds will disable the alarm until ventilation is stopped and restarted.</p> <p>It is recommended to ventilate the area around the ventilator from accumulated Oxygen prior to the 2 seconds reset.</p> </div> <p>This alarm is available with the optional internal O₂ mixer model.</p>
Check Motor Temperature Sensor	When the temperature sensor is not working properly
Check Backup Sensor	when the value of the internal pressure sensor is much smaller than the PROXLINE value

7.4 Apnea Backup Ventilation

In spontaneous ventilation modes (SPONT, VtG) FLIGHT-60 provides apnea backup ventilation when no inspiratory efforts are detected for the set Apnea Interval (see Apnea Interval settings in Section 6.3 Alarms Screen).

7.4.1 Apnea detection

If no patient inspiratory efforts are detected for the Apnea Interval period after the last breath, Apnea alarm issues.

7.4.2 Starting backup ventilation (BUV)

Immediately with Apnea alarm issuing, backup ventilation is starting.

Backup ventilation is SIMV ventilation mode with pressure control and pressure support.

Backup ventilation parameters are defined on Apnea Backup screen. The set parameters are: Rate, Ti, and PC above peep. The rest of the parameters (PEEP, PS above peep, Ptrig/Ftrig, Rise profile, PSV Flow Term., PSV Ti, %O₂, etc.) are the same as in the spontaneous mode.

once the backup ventilation starts, Apnea alarm clears and the high-priority BUV alarm issues. The Apnea LED indicator remains lit, the BUV LED indicator is blinking.

7.4.3 During backup ventilation (BUV)

When BUV is active, the controllers' area is blocked by special BUV window, so there is no possibility to change parameters.

The backup ventilation parameters are displayed on the BUV window: mode, PC, Rate and Ti values.

In addition there is an "Exit" button.

7.4.4 Exiting Backup Ventilation

BUV mode ends in either one of the following cases:

- By the patient – There are two patient-triggered breaths during the APNEA interval time.
- By the operator – Pressing "Exit" button.

In both cases, the ventilator immediately returns to the previous ventilation mode settings and the BUV alarm clears. The BUV LED indicator remains lit.

7.5 Low Power Ventilation (LPV)

FLIGHT-60 Turbine provides a low power mode of ventilation (LPV). LPV is activated in one of the following cases:

1. External power cord and detachable battery are disconnected
2. External power cord is disconnected and:
 - a. Total batteries charge level is less than 15%
 - b. Detachable battery charge level is less than 10%
 - c. Secondary battery charge level is less than 15%

LPV mode ventilation parameters:

1. Pressure Control = 15 cmH₂O
2. Rate = 15 bpm
3. P_{trig} = -20 cmH₂O

7.5.1 Cancellation of LPV Ventilation

LPV ends in either one of the following cases:

1. External power cord is connected.
2. Detachable battery is connected.
3. Total batteries charge level is greater than 15%.

In all cases, the LPV audible alarm stops. The corresponding LED indicator remains lit.



When LPV ventilation is active immediately connect the FLIGHT-60 Ventilator to external AC or DC power.



When LPV ventilation is active, a pop up message is displayed, limiting setting parameters



Pressing the Alarm Reset button to stop the LPV alarm **does not** revert the ventilation mode to the one that was active prior to the alarm.

7.6 Muting Audible Alarms

The user can mute all active alarms (except for the Fault Alarm) for 60 seconds.

To mute audible alarms:

1. On the ventilator front panel, press the **MUTE** button.

The system enters pre-silence mode. The Mute indicator is illuminated, and all alarms (except for the Fault Alarm) are silenced for 60 seconds.

Pre-silence mode can be cancelled before 60 seconds are up, by pressing the **MUTE** button again.

7.7 Resetting Alarms

When the cause for an alarm is no longer present, alarms become inactive (passive); they stabilize (latch) their corresponding LEDs (they stop blinking). latched alarms can be cleared.

To reset alarms:

1. On the ventilator front panel, press the **Alarm Reset** button.

The LED indicators will no longer lit.

7.8 Setting Up a Remote Alarm

The remote alarm feature enables monitoring device alarms from a distant station. When connected to a remote alarm system, all visible and audible alarms on the device are transmitted as an electronic signal to the remote alarm station. Other conditions, such as system shutdown (or power down) can also be detected by the remote alarm system.

The FLIGHT-60 device can be connected to a third party remote alarm system in several configurations. In order to connect the device to a remote alarm system, a special cable must be fitted to the system and integration must be conducted between the device and the remote alarm system.

Before attempting any connection, contact your provider or FLIGHT MEDICAL Technical Support, and request the FLIGHT-60 Remote Alarm Technical spec.



DO NOT rely solely upon the remote alarm!

Take precautions that PATIENT safety is not compromised!



The design, implementation, installation, and testing of the cable are the sole responsibility of the integrator, and must be done in accordance with the FLIGHT-60 Remote Alarm Technical spec, in order to ensure the proper functioning of the system and alarm.

8 Monitoring

Monitoring parameters (numeric or graphic) are displayed at all times on the Parameters, Extended, and Technical screens, to ensure continuous monitoring of the patient during ventilation.

The FLIGHT-60 provides two display options: Graphic and Numeric.

Use the Home (Parameters) button to toggle between the numeric and the graphic displays.

8.1 Graphic Display

The FLIGHT-60 displays pressure and flow waveforms by default. By tapping the monitoring area a volume waveform will replace the flow waveform with the volume waveform. An additional tap on the screen will result in waveforms being replaced by loops. An additional tap will return the default (pressure/flow waveforms) screen. When trends are "ON" an additional tap will result in trends display.

The following 6 parameters are displayed on the right side of the monitoring area:

Name	Description
PIP	Peak Inspiratory Pressure
Vte	Expiratory Tidal Volume
Vti	Inspiratory Tidal Volume
MVe	Expiratory Minute Volume
Actual Rate	Total number of patient or time activated breaths
FiO ₂	Percent of Inspired Oxygen

8.1.1 Waveforms and Loops

The FLIGHT-60 plots pressure (yellow), flow (magenta), and volume (blue) against time. A dashed line represents the zero pressure, flow and volume values on relevant graphs.



Patient triggered breaths are marked with a green pressure line.

The FLIGHT-60 can display a dynamic loop based on the following parameter combinations:

- Pressure/Volume
- Flow/Volume



Tap the monitoring area to toggle between the three different graphic displays: Flow, Volume and Loops.

Real-time waveforms and loops ranges:

Parameter	Range
Waveforms	
Airway Pressure	0 to 90 cmH ₂ O
Flow	-220 to 220 l/min
Volume	30 to 2,200 ml
Loops	
Pressure/Volume	x: 0 to 2,200 ml
	y: 0 to 90 cmH ₂ O
Flow/Volume	x: 0 to 2,200 ml
	y: -150 to 150 l/min



The ventilator uses an auto-scaling function – scales of each waveform or loop may differ based on the actual range of values to be displayed.

8.1.2 Trends

Up to 72 hours trends are available on the graphic display. To activate trends view, press the Extended button, tap "Trends" and choose "ON".

Trends are displayed on the graphics screen area; tap the loops display screen in order to view the trended parameters.



To clear the trends' memory press the Extended button, tap "Trends" and choose "CLEAR".

8.1.3 Selecting Trended Parameters

The following parameters can be trended:

1. Actual Rate
2. Peak Inspiratory Pressure (PIP)
3. Exhaled Volume (Vte)



Tap the monitoring area to toggle between the three trends displays: Rate, PIP and Vte.

8.1.4 Time Scale Adjustment

To change the time frame, tap the left \ll and right \gg arrows located at the upper corners of the trend display.



Figure 21 – Trend Display



The ventilator uses an auto-scaling function – scales of each trended parameter may differ based on the actual range of values to be displayed.

8.2 Lung Mechanics Monitoring Display

The following lung mechanics monitoring parameters can be measured with the FLIGHT-60:

Parameter (unit)	Definition
Plateau Pressure (cmH ₂ O)	The pressure applied to the small airways and alveoli.
Static Compliance – Cstat (ml/cmH ₂ O)	Static (during zero flow maneuver) compliance of the lung and chest wall.

Notes and Warnings:



Actively breathing patients can create artifacts or noise, which can affect the accuracy of the lung mechanics calculations.



Maneuvers are available both in volume control and pressure control and when the average inspiratory flow of the breath before the maneuver is more than 15LPM.

Maneuvers are available in SIMV and ACMV modes of ventilation

Maneuvers are not available during active nebulization

The Maneuver length is 3 seconds.

8.2.1 Lung Mechanics Monitoring Display

Lung mechanics display is located on the main monitoring area of the screen and is displayed automatically for 10 seconds.

Cstat 64.5	--
Pplat 10.1	
--	

To switch back to the main ventilation parameters display either touch the tabulated area of the screen or wait 10 seconds.

8.3 RSBI Monitoring

RSBI monitoring can be viewed by tapping the main ventilation parameters display table located on the right side of the screen.

RSBI is the actual rate divided by the exhaled tidal volume [1/min*L].

RSBI is displayed only during SPONT mode.

8.4 Additional monitoring parameters display

The default FLIGHT-60 numeric display located on the right side of the screen shows the following parameters: Actual rate, PIP, MVE, FiO₂, Vti and Vte.

To access additional 8 parameters - touch the numeric monitoring area of the screen. The following parameters will be displayed:

- PIF – the measured peak inspiratory flow in liters per minute.
- I:E – inspiratory to expiratory ration.
- P base – the actual measured PEEP value.
- P mean – the average pressure measured over a breath cycle.
- RSBI – Rapid shallow breathing index. [1/min*L]
- Cdyn – Dynamic Compliance. [ml/cmH₂O]
- MVi – Inspiratory Minute Volume (appears on the 3rd Screen).
- % Leak – percentage leak of the last breath (appears on the 3rd Screen)

PIF [LPM] 43	I: E 1:1.5
P base 11	P mean 16
RSBI 82	Cdyn 22.2

MVi [LPM] 7.5	LEAK 0.3%

2nd screen3rd screen

To switch back to the main ventilation parameters display either touch the table area of the screen or wait 10 seconds.

8.5 Numeric Display

The FLIGHT-60 default display is graphic. Use the Parameters button to toggle between the numeric and the graphic displays.

The following table describes the patient monitoring parameters.

Name	Description	Range	Resolution	Updated
PIP	Peak Inspiratory Pressure	0 to 120 cmH ₂ O	1 cmH ₂ O	Breath by breath
P base	Baseline airway pressure at the end of expiration	0 to 99 cmH ₂ O	1 cmH ₂ O	Breath by breath
P mean	Mean airway pressure	0 to 99 cmH ₂ O	1 cmH ₂ O	Breath by breath
Vte	Expiratory Tidal Volume	0 to 10 L	10 ml	Breath by breath
Vti	Inspiratory Tidal Volume	0 to 10 L	10 ml	Breath by breath
MVe	Expiratory Minute Volume	0 to 99L/min	1 L/min	10 seconds rolling average
MVi	Inspiratory Minute Volume	0 to 99L/min	1 L/min	10 seconds rolling average
Actual Rate	Total number of patient or time activated breaths	99 b/min	1 b/min	Breath by breath
I:E	I:E Ratio	1:99 to 3:1		
	Note: I:E Ratio is determined by the <i>f</i> and Ti settings. If the expiratory time is longer than the inspiratory time, the display format is 1:X.X. If the expiratory time is shorter than Ti, the display format is X.X:1.			
PIF	Peak Inspiratory Flow	6 to 220 L/min	1 L/min	Breath by breath
FiO ₂	Fraction of Inspired Oxygen	21% to 100% O ₂	1%	Every 10 seconds
%Leak	Percentage leak of the last breath	0% to 100%	1%	Breath by breath

Name	Description	Range	Resolution	Updated
	 <i>%Leak is displayed only if NIV=on</i>			

9 Ventilation Modes

The ventilator can be switched between the following ventilation modes:

- **ACMV** (Assist/Control Mandatory Ventilation)
- **SIMV** (Synchronized Intermittent Mandatory Ventilation)
- **SPONT** (CPAP/PS Ventilation)
- **VG** (Volume Guarantee Ventilation)
- **B-LEV** (Bi-Phasic Ventilation)
- **HFOT** (High Flow Oxygen Therapy)

→ To set the ventilation mode:

1. Tap the control button.
The **ACMV/SIMV/SPONT/ MORE** options are displayed.



Figure 22 – Available modes

2. Tap the requested mode option. It turns orange.
3. Press the **OK** (Enter) key to confirm your selection.
the chosen mode appears on the button.
4. Taping the **MORE** option pages to the next group of modes options:
VtG/MVG/B-LEV/MORE.
5. Additional taping on the **MORE** option pages to the last group (**HFOT** mode) or returns to the first page in case that **HFOT** is not enabled.
6. If NIV option is chosen, all the modes appear with "NIV" title. NIV is available in all the modes except the HFOT.

9.1 ACMV Mode (Assist Control Mandatory Ventilation)

In ACMV mode, time activated (mandatory) breaths are delivered in accordance with the *Rate* setting. Patients can trigger mandatory breaths in addition to, or in place of, time activated (mandatory) breaths, if the effort that they generate causes airway pressure to meet the *P_{trig}* or *F_{trig}* setting. Each such patient effort results in a mandatory breath. The breath can be volume or pressure controlled. PEEP may be added. Tidal volume is determined by the target pressure, *T_i*, patient respiratory mechanics in Pressure Control, and by the tidal volume setting in Volume Control.



In **ACMV** mode, the **PS above peep**, **PS Flow Term** and **PS Ti** control buttons are not utilized and are therefore darkened. However, they remain adjustable.

9.2 SIMV Mode (Synchronized Intermittent Mandatory Ventilation)

In SIMV mode, patients receive a fixed or pressure controlled mandatory breaths (time or patient activated) and may breathe spontaneously between mandatory breaths, with or without pressure support (PS). See Figure 23 for a schematic illustration. PEEP may be added.

The first patient triggered breath in any mandatory breath interval is a patient triggered mandatory breath. The patient has the rest of the interval to breathe spontaneously. If the patient does not trigger the ventilator, and one complete mandatory breath interval has elapsed, a time triggered mandatory breath is delivered.

A mandatory breath lockout interval is activated whenever the patient triggers a mandatory breath. This limits the number of mandatory breaths (time triggered or patient triggered) that the patient receives in 60 seconds, to the *Rate* (b/min) setting.

Figure 23 – Synchronized Intermittent Mandatory Ventilation (SIMV)

9.2.1 VCV/PCV/PRVC

In ACMV and SIMV modes, the control type can be one of three:

- **Volume Control (VCV)** **Pressure Control (PCV)**
- **PRVC** – Pressure Regulated Volume Control

In all cases, all breaths delivered to the patient, whether time (ventilator initiated) or patient-triggered, are the same.



In **SPONT** and **B-LEV** modes, the **PCV/VCV/PRVC** button is not utilized and is therefore darkened; however, the value can be preset.

9.2.1.1 Volume Control Ventilation (VCV)

The user can define which parameter will remain constant when changing the VC – Flow or Ti. Once the parameter is selected, its value can be adjusted; then, any change of volume modifies the other parameter.

The system supports two modes of flow waveform:

- **Square** – The flow is constant during the inspiratory phase.
- **Descending** – The flow decreases gradually during the inspiratory phase.



Make sure that the mandatory flow setting is adequate to meet patient flow demands.



In **ACMV VCV** mode, the **Rise Profile** control button is not utilized and is therefore darkened. However, it remains adjustable.

The VCV mode delivers volume controlled breaths as the mandatory breaths. The user can set the volume and select whether the Ti or the Flow will adjust to fit the set volume. The user can define which parameter will remain constant when changing the VT – Flow or Ti. Once the parameter is selected, its value can be adjusted; then, any change to the volume will modify the other parameter.

The tidal volume delivered to the patient is limited by the minimal and maximal flow of the system.

If the Volume Control setting causes the flow rate to reach the maximum or minimum level of the flow specification, adjustment of Volume Control ceases, and a setting limitation message appears in a pop-up window.



When Volume Control is first initiated, it may take five or six breaths to reach the volume setting.

➔ *To set the VCV sub mode of operation:*

1. Tap the control button.
The PCV/VCV/PRVC sub-modes are displayed.

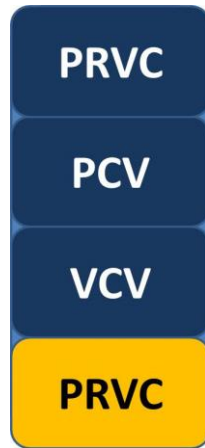

Figure 24 – Available Sub-modes

2. Tap the **VCV** option.
3. Press the **OK** (Enter) button to confirm your selection. VCV appears on the button.

The **VT** control button appears on the Parameters screen, with its predefined numerical value.



Figure 25 – The VT Control Button (Tidal Volume)

9.2.1.1.1 Mandatory Tidal Volume

During Volume Control ventilation, tidal volume can be set for mandatory breaths. If a volume setting is changed while the ventilator is operating, the change takes place in increments over a series of breaths.



When a large change is made to the volume setting, it may take five or six breaths to reach the volume setting.

➔ *To set the target volume:*

1. Tap the **VT** control button.
2. Adjust the VT value (tidal volume), using the **+/-** button.

9.2.1.2 Pressure Control Ventilation (PCV)

The FLIGHT-60 Ventilator targets and maintains patient airway pressure at the set pressure control level throughout inspiration. Breath termination occurs when either of the following conditions exists:

- The set T_i elapses.
- The Peak inspiratory pressure exceeds the Pressure Control setting by 8 cmH₂O (mbar).

Maximum airway pressure never exceeds the user set High pressure alarm limit setting.



The target airway pressure for pressure controlled mandatory breaths in ACMV and SIMV is the display setting above PEEP; not above ambient pressure.



In **PCV** mode, the **Waveform**, and **Ti/Flow ctrl** control buttons are not utilized and are therefore darkened. However, they remain adjustable.

Both time and patient triggered mandatory breaths can be delivered in ACMV and SIMV Pressure Control operation. During SIMV Pressure Control operation, patients can breathe spontaneously between mandatory breaths with or without pressure support.



When disconnecting the patient circuit during PC/PS ventilation, such as for suctioning, the flow may increase in order to compensate for the low pressure. After reconnecting the patient circuit, the flow automatically readjusts to meet the patient's demand.

The PCV mode delivers pressure controlled breaths as the mandatory breaths.



When Pressure Control is first initiated or the setting is changed, the first few breaths may cycle off early until the rise profile is optimized. If early cycling off continues, reevaluate the patient circuit configuration and lengthen the tubing as necessary.



The minimum target airway pressure is 5 cmH₂O/mbar above the set baseline pressure (PEEP).

➔ *To set the PCV sub mode of operation:*

1. Tap the control button.

The PCV/VCV/PRVC sub-modes are displayed.



Figure 26 – Available Sub-modes

2. Tap the **PCV** option to select it.
3. Press the **OK** (Enter) button to confirm your selection.

PCV appears on the button.

The **PC** above peep control button appears on the Parameters screen, with its predefined numerical value.

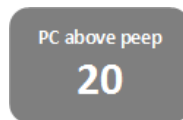

Figure 27 – The PC Control Button (Target Pressure)

9.2.1.2.1 Target Pressure

➔ To set the target pressure:

1. Tap the **PC** above peep control button (see Figure 27).
2. Adjust the PC value (the target pressure), using the **+/-** button.

9.2.1.3 Pressure Regulated Volume Control (PRVC)

In PRVC, breaths are pressure control while the pressure level is automatically adjusted in order to achieve the preset target volume.

The maximum airway pressure never exceeds the user set High pressure alarm limit setting.

The following primary breath controls are required for PRVC mode:

- Target VT – The target tidal volume.
- Rate – Breath rate.
- Ti – Inspiratory time.

PRVC is available in both ACMV and SIMV.



Pressure and volume limits should be set in PRVC to prevent unintentional pressure and volume changes.

To set the PRVC sub mode of operation:

1. Tap the sub-modes control button.

The PCV, VCV and PRVC sub-modes are displayed.



Figure 28. Available Sub-modes

2. Tap the **PRVC** option to select it.
3. Press the **OK** (Enter) button to confirm your selection.

9.3 SPONT Mode (Spontaneous Ventilation)

In SPONT mode, mandatory breaths are not delivered. However, the caregiver can adjust both PEEP/CPAP and pressure support (PS) levels. The patient has control over each breath.

When PEEP/CPAP is set above 0, the ventilator mode is CPAP (without PSV) or Bi-level Positive Airway Pressure (with PSV). Ensure that P_{trig} or F_{trig} is set so that the FLIGHT-60 Ventilator detects all spontaneous patient efforts.

Entries for tidal volume, *Rate* and *Ti* are all inactive in SPONT mode. However, users can preset these parameters for future ACMV or SIMV operation.

Backup Ventilation is activated if the Apnea alarm limit is violated.



In **SPONT** mode, the Rate, Ti, PC above peep, Waveform, Trigger delay, and SIGH control buttons are not utilized and are therefore darkened. However, they remain adjustable.

9.4 VtG (Tidal Volume Guarantee)

VtG is a volume target mode which is a sub mode of the SPONT mode. The VtG mode changes the pressure support level in order to achieve a targeted tidal volume. VtG mode is pressure mode as each breath is a pressure support breath triggered by either the patient (spontaneous) or the machine.

In VtG mode, the target volume is reached by controlling the pressure support applied to the patient based on three parameter settings:

- **VT** – The target tidal volume.
- **PS min** – The minimum pressure allowed by the operator.
- **PS max** – The maximum pressure allowed by the operator.



Pressure and volume limits should be set in Volume Guarantee mode to prevent unintentional pressure and volume deviations

9.5 MVG (Minute Volume Guarantee)

The same as VtG mode. But in MVG mode pressure support breath could be triggered by either the patient (spontaneous) or the machine.

In MVG mode, when the patient fails to trigger a breath within the interval determined by the Rate control, the ventilator triggers a mandatory breath with a set Ti. The Rate, in combination with the Target VT setting, determines the minimum delivered minute volume.

The following controls are required for MVG mode:

- **VT** – The target tidal volume.
- **PS min** – The minimum pressure that can be applied.
- **PS max** – The maximum pressure that can be applied.
- **Rate** – The minimum rate (determines the interval).
- **Ti** – inspiratory time.

9.5.1 Trigger Delay

In MVG mode, Trigger Delay function doubles the delay time before mandatory (time cycled) ventilation is activated.

When Trigger Delay is set to OFF, the ventilator will trigger a mandatory breath after a period equal to 60 divided by the set Rate. When Trigger Delay is set to ON, the ventilator

will delay triggering a mandatory breath. The total time for a mandatory breath to be triggered will equal twice the “OFF” time.



To avoid low rate due to intermittent spontaneous patient efforts, the FLIGHT-60 automatically deactivates the trigger delay when the actual rate is lower than the set rate.

To set the Trigger Delay:

1. On the ventilator front panel, press the **Extended** button.
2. Tap the **Trigger Delay** control button.
The control button turns orange, and a pop-up list displays two options: ON and OFF.
3. To activate **Trigger Delay**, tap the control button to select **ON**; to deactivate the **Trigger Delay**, tap the control button to select **OFF**.

9.5.1.1 PS min and PS max initial values

When switching to a Volume Guarantee mode (VtG or MVG) the following initial values will be applied:

PS min = PS setting – 5; PS min > 5
PS max = PS setting + 10.



When exiting VG Mode, PSV control button will be set to PSV min.

9.6 B-LEV Mode (Bi-Phasic Ventilation)

Bi-Level is a time-cycled pressure mode. The ventilator cycles between two different baseline pressures based on time. In this mode the patient can breathe spontaneously at both the high and low pressure baselines. Pressure support can be added during the low pressure baseline period to improve comfort.

When the patient triggers a pressure support breath during the Pressure Low period, the transition from Pressure Low to Pressure High occurs 1 second from the end of inspiration.

The following controls are required for Bi-Level mode:

- **P low** – the low pressure baseline.
- **P high** – the high pressure baseline.
- **T low** – the low pressure baseline period.
- **T high** – the high pressure baseline period.
- **PS above peep** – the pressure support level.

9.7 NIV (Non-Invasive Ventilation)

Non-invasive ventilation is available for all ventilation modes (except HFOT). FLIGHT-60 Turbine provides auto-leak compensation up to 100 L/min in all modes of ventilation.

NIV can be accessed from the "Extended" menu. When NIV is active, the operating mode buttons indicate that NIV ventilation is ON.



When NIV is on the following alarms are disabled: "Check Circuit", "Low VTe", "Low MVe"

➔ To set NIV:

1. On the ventilator front panel, press the **Extended** button.
2. Tap the **NIV** control button.

The control button turns orange, and a pop-up list displays two options: ON and OFF.



Figure 29 – NIV

3. Press the **OK** (Enter) button to confirm your selection.

The selection is displayed on the control button.

9.8 HFOT

HFOT stands for High Flow Oxygen Therapy.

This mode is enabled only in ventilators with an internal oxygen mixer.

HFOT provides a continuous flow of a predefined oxygen percentage.

It works with fully open exhalation valve and does not provide any breath control or support.



WARNING

HFOT mode must be used with a heated patient circuit and an active humidifier



Switching between HFOT and other modes is not possible during ventilation. To switch from HFOT to other ventilation modes or vice versa the user must stop ventilation.

The following controls are required for HFOT mode:

- **HFOT flow** – the constant target flow.
- **%O₂** – the target oxygen concentration.

Overview of HFOT in FLIGHT-60 Turbine

High Flow Oxygen Therapy (HFOT) is a mode of ventilation in which the FLIGHT-60 Turbine provides continuous air flow with Oxygen.

When selected internally according to set values for HFOT flow and %O₂, the turbine is controlled for constant overall flow, while the oxygen solenoid controls the oxygen flow using the feedback from flow sensors, and FiO₂ sensor. Alarms – HFOT has the following alarms: FiO₂ low and high alarms, Flow Blockage Alarm. Parameters: Flow Target (10 -60 LPM), FiO₂ (21 – 100%).

Intended Use;

The HFOT mode is for the treatment of spontaneously breathing patients who would benefit from receiving high flow warmed and humidified respiratory gases. This includes patients who have had upper airways bypassed. The flow may be from 10 – 60 L/min depending on the patient interface. The HFOT mode is for patients in hospitals and long-term care facilities.

Warnings:

- Nasal delivery of respiratory gases generates flow-dependent positive airway pressure (PAP). This must be considered where PAP could have adverse effects on a patient.
- HFOT is not intended for life-support.
- To avoid burns the type of interface, water chamber and breathing circuit used should be taken into consideration.

Contraindication to HFNC include abnormalities or surgery of the face, nose, or airway that preclude an appropriate-fitting nasal cannula. Complications are rare and include abdominal distension, aspiration, and rarely barotrauma.

10 Special Functions

10.1 Nebulizer (OPTIONAL)

The nebulizer feature provides a synchronized flow of 7LPM (± 1 LPM) to power a pneumatic nebulizer connected to the nebulizer outlet.

The in-line nebulizer is powered by 100% O₂ and synchronized with the patient inspiratory phase of each breath and can be adjusted in increments of 5 minutes for maximum of 60 minutes.

The ventilator volume ventilation algorithm compensates for the additional in-line volume.

The nebulizer should be connected to the inspiratory limb per the institution's policy and procedures. Connecting the nebulizer between the flow sensor and the endotracheal tube increases the dead space ventilation.

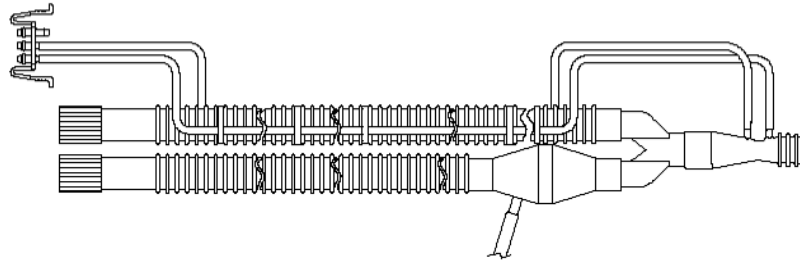

Figure 30 – Nebulizer Assembly

➔ To set up the nebulizer:

1. Securely attach the nebulizer to the port on the front panel.
2. On the ventilator front panel, press the **Extended** button.
3. Tap the **Nebulizer** control button.

The control button turns orange, and a pop-up list displays the two unit options: **ON** and **OFF**.

4. To activate the nebulizer, tap the control button to select **ON**; to deactivate the nebulizer, tap the control button to select **OFF**.
5. Press the **OK** (Enter) button to confirm your selection.

Your selection (ON or OFF) is displayed on the control button.

The nebulizer period controller is configured when setting up the ventilator.

➔

To configure the nebulizer period controller:

1. On the ventilator front panel, press the **Technical** button.
2. Tap the **Nebulizer Period** control button.
The control button turns orange.
3. Adjust the nebulizer period using the +/- button until you reach the desired value.
4. Press the **OK** (Enter) button to confirm your selection.
Your selection is displayed on the control button.

10.2 2 Minutes 100% O2 (OPTIONAL)

The 100% O2 function increases the oxygen concentration delivered to the patient to 100% for 2 minutes. If switched OFF within the 2 minutes period the ventilator returns to the prior %O2 settings. Oxygen alarms are disabled during the 100% O2 maneuver.

➔ *To set 100% O2:*

1. On the ventilator front panel, Tap the **100% O2** control button.
The control button turns orange, and a pop-up list displays the two options: ON and OFF.
2. To activate 100% O2, tap the control button to select **ON**; to deactivate the 100% O2, tap the control button to select **OFF**.
3. Press the **OK** (Enter) button to confirm your selection.
Your selection (ON or OFF) is displayed on the control button.

10.3 SIGH

A sigh breath is a volume-controlled breath that equals to 150% of the set volume (VT settings). When the sigh feature is enabled, the ventilator delivers a sigh breath every 100th mandatory or assisted breath.

The sigh feature is available in volume ventilation modes only.

➔ *To set SIGH:*

1. On the ventilator front panel, press the **Extended** button.
2. Tap the **SIGH** control button.
The control button turns orange, and a pop-up list displays two options: ON and OFF.



Figure 31 – SIGH Sub-modes

3. To activate SIGH, tap the control button to select **ON**; to deactivate the SIGH, tap the control button to select **OFF**.
4. Press the **OK** (Enter) button to confirm your selection.

Your selection (ON or OFF) is displayed on the control button.

10.4 Manual Breath



Pressing the **Manual Breath** button  delivers an operator initiated manual inflation. However, the Manual Breath button does not initiate an inflation, if the patient is currently in the inspiratory phase of a breath, or if the airway pressure is > 5 cmH₂O (mbar) above the set PEEP level. Manual Breath delivers the set flow rate (in Volume Control) or the set target pressure (in Pressure Control); however, inspiratory time is controlled by the user.

During Manual Breath, the breath is terminated if any of the following occurs:

- The Manual Breath button is released.
- The High Pressure alarm is violated.
- Three seconds have elapsed.



Manual Breath is only available in ACMV and SIMV modes.



Manual Breath may be prematurely cycled off in the first several breaths in Pressure Control, when the initial flow has not yet been optimized.

10.5 Panel Lock

→ *To lock the panel:*

1. Press the **Panel Lock** button twice within five seconds.

The LED turns on. All buttons are disabled for adjustment, except for the Mute/Alarm Reset button.

→ *To unlock the panel:*

1. Press the **Panel Lock** button once and then press the **OK (Enter)** button.

The Panel Lock button is deactivated.

10.6 Preset Ventilation Configurations (optional)

Quick Presets is an optional feature that provides a quick access to saved ventilation configurations directly from the main screen upon turning the ventilator "ON".

When Presets is enabled the following options are available on the main screen upon turning the ventilator "ON":

Last Patient: choose to resume ventilation of the current patient.

Adult: choose to load preset #1 labeled "Adult"

Pediatric: choose to load preset #2 labeled "Pediatric"

SPONT (CPAP): choose to load preset #3 labeled "SPONT (CPAP)"

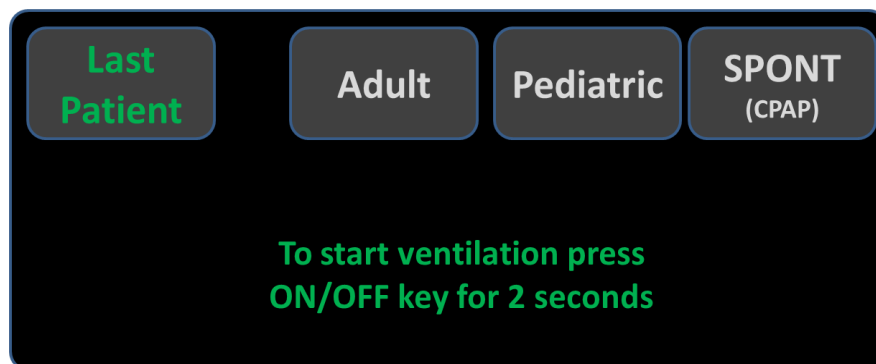

Press the OK button to confirm preset selection.



Always make sure control parameters and alarm limits are appropriately set before starting ventilation.

10.6.1 Quick-Start: Factory default settings

The table below shows the factory default control setting for the Adult, Pediatric and SPONT configurations presets.

Parameter	Adult (preset #1)	Pediatric (preset #2)	SPONT/CPAP (Preset #3)
Mode	SIMV-VCV	SIMV-PCV	SPONT
VT	500	15	-
Rate	12	25	12
Ti	1.2	0.8	1.2
PEEP	5	5	5
PS above peep	7	7	7
F Trig	1	1	1
%O ₂	50	50	50



%O₂ value will be set according to the table if O₂ configuration is ON

10.6.2 Setting and loading the preset ventilation configurations

Up to five preset configurations can be stored on the ventilator allowing loading a full set of ventilation parameters with only two key strokes. Storing a specific set of parameters is done through the Technical screen as explained below:

➔ *To store a preset ventilation configuration:*

1. On the ventilator front panel, press the **Technical** button.

The Technical parameters are displayed on the ventilator screen.

2. Tap the **Set Save** control button and enter the 1315 access code.



The Set Save function is password protected, only if Quick Start is enable. It is password protected to prevent undesired change to preset configurations.

Select the desired preset number to save by tapping the on-screen button, confirm by pressing the OK button.

The patient configuration is saved.

To load a preset ventilation parameters configuration:

1. On the ventilator front panel, press the **Technical** button.

The Technical parameters are displayed on the ventilator screen.

2. Tap the **Set Load** control button.

The control button turns orange, and a pop-up list with the identifying numbers of the saved configurations appears.

3. Tap the control button that corresponds to the number of the saved configuration you would like to load. For example, to load configuration 2, tap the control button with the number 2.

10.7 In-Use O₂ Sensor Calibration



In-use calibration is available for both internal and external O₂ mixer FLIGHT-60 models, please follow the on-screen instructions.



In-use calibration should only be performed on clinically stable and synchronized patients. If any alarm is being activated, the calibration procedure must be aborted.



The low flow port should be disconnected during in-use O₂ calibration

In-use O₂ sensor calibration alternatives:

1. A 2 points calibration at 100% and 21% oxygen concentrations
2. A single point calibration at 100% oxygen concentration
3. A single point calibration at 21% oxygen concentration

In-use calibration can be performed while patient's ventilation continues. Please consider the changes in oxygen delivery while calibration is on going before performing in-use calibration.

To perform in-use O₂ calibration:

On the ventilator front panel, press the Technical button. The Technical parameters are displayed on the ventilator screen.

To start in-use sensor calibration, tap the "FiO2 Sensor" control button to select "Calibrate".

Press the OK (Enter) button to confirm your selection.

Follow the on-screen instructions.



During the 100% calibration of the oxygen sensor the ventilator delivers 2 minutes 100% oxygen concentrations to the patient.



During the 21% calibration of the oxygen sensor the ventilator delivers 2 minutes 21% oxygen concentrations to the patient.



For accurate %O₂ delivery of 40% oxygen and above a 2 points (21% and 100% oxygen concentrations) calibration is recommended.

To abort in-use O₂ calibration:

On the ventilator front panel, press the Technical button.

The Technical parameters are displayed on the ventilator screen.

To abort in-use sensor calibration, tap the "FiO₂ Sensor" control button.

Press the OK (Enter) button to confirm your selection.

10.8 Altitude Compensation

The FLIGHT-60 ventilator automatically maintains precise volume delivery in altitudes up to 15,000 feet (4,500 meters). The manual altitude adjustment is only for the flow and volume accuracy measured by the proximal flow sensor.

Altitude can be set with the "Altitude Comp." button located on the Extended screen. Altitude compensation is set to "OFF" by factory default.

Altitude Comp.
3000 m

Figure 32. Altitude Compensation button located on the Extended screen

Altitude can be displayed in meters or feet, to change the displayed units go to the "Set Clock" (Technical screen) and select "EUR" for meters or "USA" for feet.



For accurate Vte and Vti monitoring and alarms ensure that the altitude is set.

11 Accessories

11.1 Air/Oxygen Entrainment Mixer

The Air/Oxygen Entrainment Mixer is used to blend atmospheric air with medical grade oxygen at a precise ratio. A control knob allows for incremental adjustment from 21% to 100% FiO₂. The high pressure oxygen hose has a standard female DISS 1240 connection. The Mixer attaches to the Fresh Gas Intake of the FLIGHT-60 Ventilator on the Filter Cover, located on the right side of the ventilator.

Pneumatic Requirements: Oxygen 35-90 psig (2.4 to 6.2 Bar)



High Pressure Oxygen Mixer

12 Cleaning and Maintenance

12.1 Cleaning and Disinfecting

The FLIGHT-60 Ventilator and associated patient circuits are shipped in clean but not sterile condition. Reusable (single patient) patient circuits should be disinfected before reapplying to the patient.

Use the information in this section in conjunction with hospital policy, physician prescription, or Homecare Dealer instructions.

12.1.1 FLIGHT-60 Ventilator

Wipe clean the FLIGHT-60 Ventilator between patients, and once a week while in use.

→ *To clean the ventilator:*

1. Wipe clean the exterior (besides the screen) of the ventilator and all parts not in direct contact with patients, using a cloth that has been dampened with a medical detergent or alcohol-based cleaning solution.
2. Clean the front panel display (the screen) using a lint free damp cloth dampened with LCD cleaner solution.
3. Air dry.



CAUTION

Do not apply the cleaning solution directly on the screen.



CAUTION

On the front panel display or ventilator housing, do not use agents that contain acetone, toluene, halogenated hydrocarbons, or strong alkaline.



CAUTION

Never autoclave or ETO sterilize the FLIGHT-60 Ventilator and its accessories. These processes will damage the FLIGHT-60 Ventilator and accessories, rendering them unusable.

12.1.2 FLIGHT-60 Ventilator Accessories

All accessories should be thoroughly cleaned, rinsed, and air dried prior to disinfecting. Examine all accessories for excessive wear or damage. Discard and replace if necessary.

12.1.2.1 Reusable (Single Patient) Patient Circuits

The patient circuit includes 22mm ID breathing tube, exhalation valve and flow sensing kit (flow orifice, quick connector and triplet 2.75mm ID tubes).



FLIGHT MEDICAL patient circuits are supplied non-sterile.

Clean and disinfect patient circuits once weekly while in use. Always use a clean, disinfected exhalation valve when the patient circuit is reassembled for patient use.

Examine the patient circuit for excessive wear or damage. Discard and replace, if necessary. To avoid degradation of the reusable (single patient) patient circuit components, do not exceed 20 cleaning cycles or half a year of usage (whichever occurs first).



HOME CAREGIVERS: In the home environment, it is important to always use a clean, disinfected patient circuit. The objective of cleaning circuits is to render the surfaces free of pathogens.

➔ *To disassemble the patient circuit:*

1. Remove the entire circuit from the ventilator.
2. Remove the exhalation valve and flow sensing kit.
3. Disassemble the circuit to expose all surfaces for cleaning.



The FLIGHT MEDICAL patient circuit is manufactured from a Polyester Elastomer, high-temperature material and incorporates a silicone rubber cuff. To avoid damage to the circuit, attach and detach the circuit by handling only the silicone cuffs. Do not pull or twist the circuit.

If you are using a FLIGHT MEDICAL patient circuit, refer to the cleaning and disinfecting directions below. If you are using another manufacturer's patient circuit approved by FLIGHT MEDICAL, refer to the manufacturer's instructions for cleaning.

➔ *To clean the patient circuit:*

1. Use a low flow of running water or air to clear tubing and passages of organic matter.
2. Bathe for a minimum of 10 minutes using mild detergent or liquid cleanser.
3. Wash all components of the patient circuit with a soft brush.
4. Rinse thoroughly with sterile, distilled water, removing all traces of the cleanser.
5. Shake off excess water, and place all parts on a clean towel to air dry (do not heat or blow dry.)

➔ *To disinfect the patient circuit components:*

1. Soak plastic and metal parts in any of the following solutions:

- One part 5% Acetic Acid (white vinegar) and two parts sterile, distilled water for two hours (for home use only)
 - Glutaraldehyde solution (Cidex [2%]) for two hours
2. Rinse with sterile, distilled water, removing all traces of the cleanser.
 3. Air dry.



Patient circuit components should NOT come in contact with the following solutions, because they may cause disintegration of the tubing: Hypochlorite, Phenol (>5%), Inorganic Acids, Formaldehyde, Ketone, Chlorinated Hydrocarbons, and Aromatic Hydrocarbons.



Patient circuits should be inspected after disinfecting to check for deterioration. If the circuit is damaged or shows excessive wear, replace with a new circuit.

12.1.2.2 Reusable (autoclavable) patient circuits and flow sensor kits



Steam Autoclave



Patient circuits and flow sensor kits are supplied non-sterile.



Visually inspect the circuit components kit for excessive wear or damage, discard if there is any sign of damage or if it fails the "Circuit TEST".

→ To clean the patient circuit:

1. Rinse the circuit components with water and air to clear flow sensor tubing and passages of soil residuals.
2. Soak the circuit components a mild detergent, for at least 10 minutes.
3. Thoroughly wipe all the external surface of the test article with a soft cloth, moistened with detergent solution to remove any visible soil residuals.
4. Rinse the circuit components thoroughly under distilled water for at least 30 seconds, to remove all traces of the detergent.
5. Shake off excess water, and place all parts on a clean towel to air dry.
6. Sterilize using a validated autoclave procedure at 134°C (273°F).
7. Dry the circuit components by shaking off excess water, and place all parts on a clean towel to air dry.



Replace after 40 autoclave cycles at 134°C (273°F)

12.1.2.3 Reusable (Single Patient) Exhalation Valve

Clean and disinfect the Exhalation Valve twice weekly, while in use.



Figure 33 – Exhalation Valve Assembly

→ To disassemble the exhalation valve:

1. Remove the exhalation valve from the patient circuit (see Figure 33).
2. Rotate counterclockwise the top cap of the exhalation valve and lift it off.
3. Lift out the valve drive line fitting, and separate it from the diaphragm (see Figure 34).

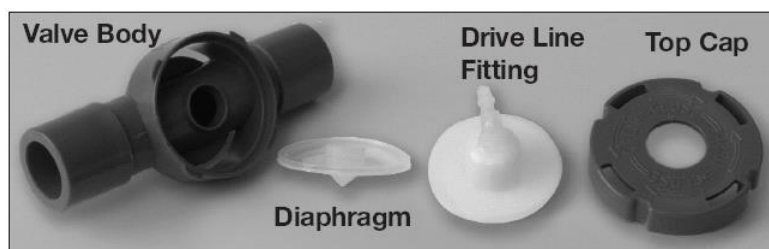

Figure 34 – Exhalation Valve Disassembled Parts

➔ *To clean the exhalation valve:*

1. Use a low flow of running water or air to clear tubing and passages of organic matter.
2. Wash the exhalation valve with a soft brush.
3. Rinse thoroughly with sterile, distilled water.
4. Shake off excess water, and place it on a clean towel to air dry (do not heat or blow dry)

➔ *To disinfect the exhalation valve:*

1. Soak plastic and metal parts in any of the following solutions:
 - One part 5% Acetic Acid (white vinegar) and two parts sterile, distilled water for two hours (for home use only); then rinse with sterile distilled water.
 - Glutaraldehyde solution (Cidex [2%]) for two hours; Then, rinse with sterile, distilled water.
 - Boiling distilled water; boil the water for 15 minutes, making sure that water covers the valve at all times. Allow the water to cool and then drain (for home use only).
2. Air dry.

After the exhalation valve is dry, reassemble it according to the following procedure, to ensure proper ventilator operation.

➔ *To reassemble the exhalation valve:*

1. Carefully seat the diaphragm so that it lies flat on the white plastic drive line fitting and snaps on around the edge completely.
2. Place the fitting/diaphragm assembly in the valve body, with the drive line fitting lined in the opposite direction of the patient and/or the arrow sign.
3. Carefully place the cap over the fitting/diaphragm assembly and turn the cap clockwise until it comes up against the stop.
4. Perform an exhalation valve calibration to ensure proper operation of the ventilator.



Do not try to turn the drive line fitting after securing the cap. This may cause the diaphragm to become wrinkled or unseated and affect ventilator performance.

12.1.2.4 Reusable Dual Limb Exhalation Valve and Diaphragm

➔ *To disassemble the exhalation valve:*

1. Disconnect the patient circuit.
2. Press the pin and rotate the exhalation valve cover 1/4 turn counter clockwise.
3. Carefully remove the diaphragm by pulling the diaphragm tip.

→ *To clean the dual limb exhalation valve and diaphragm:*

1. Wash the dual limb valve and diaphragm with a soft brush using mild detergent (such as liquid soap).
2. Rinse the exhalation valve and diaphragm thoroughly with sterile, distilled water.
3. Shake off excess water, and place it on a clean towel to air dry (do not heat or blow dry.)

→ *To disinfect the dual limb exhalation valve and diaphragm:*

Wipe with an appropriate bacterial agent after each patient use or soak the valve and diaphragm in any of the following solutions:

- One part 5% Acetic Acid (white vinegar) and two parts sterile, distilled water for two hours (for home use only); then rinse with sterile distilled water.
- Glutaraldehyde solution (Cidex [2%]) for two hours; Then, rinse with sterile, distilled water.
- Boiling distilled water; boil the water for 15 minutes, making sure that water covers the valve at all times. Allow the water to cool and then drain (for home use only).

Refer to Section 4.6 - Attaching the Patient Circuit for the dual limb patient circuit assembly instructions.



NOTE: Flight Medical appreciates that cleaning and disinfection practices vary widely among healthcare institutions. It is not possible for Flight Medical to specify specific practices that will meet all needs, or to be responsible for the effectiveness of cleaning and disinfecting in the patient care setting. This manual can only provide general guidelines for cleaning and disinfecting. It is the user's responsibility to ensure the validity and effectiveness of the methods used.

12.1.2.5 FLIGHT-60 Ventilator Air Inlet Particle Filter



NEVER operate the FLIGHT-60 Ventilator without a clean inlet particle filter in place.



NEVER reverse the inlet particle filter when it is dirty.

The air inlet particle filter, located on the right side of the ventilator behind the Filter Cover, keeps dirt and particles out of the ventilator's piston system. As

the filter becomes dirty, it can reduce the volume of air drawn into the ventilator.

Check the inlet filter weekly. Replace it with a new filter when the majority of the filter surface area has changed from a clean white to dirty brown color. Inlet filters are not reusable.



After replacing the filter, make sure that the three hold down screws on the Filter Cover are secure. If the screws are not tight, ambient air may enter the FLIGHT-60 Ventilator from around the inlet cover.



HOME CAREGIVERS: When the FLIGHT-60 Ventilator is used in a homecare environment, the filter may become dirty more frequently and therefore must be inspected and/or changed more often.



HOME CAREGIVERS: It is common practice to have two patient circuits available in homecare environments to ensure that a clean circuit is always available for regularly scheduled circuit changes. The exhalation valve in each circuit must be calibrated before use.

12.2 Maintenance

12.2.1 Preventive Maintenance

It is recommended to take the following measures to maintain the FLIGHT-60 Ventilator:

- Check the Air Inlet Filter (located behind the Filter Cover) weekly. Replace it when the majority of the filter surface area has changed from a clean white to dirty brown color. Air Inlet Filters are not reusable.



HOME CAREGIVERS: When the FLIGHT-60 Ventilator is used in homecare environments, the filter may become dirty more frequently and therefore, it must be inspected and/or changed more often.



NEVER reverse the inlet particle filter when it is dirty.

- Inspect the FLIGHT-60 Ventilator power cord on a regular basis, for signs of a broken or frayed power cord.
- Inspect the exhalation valve and flow orifice to verify that there are no cracks or damaged surfaces.
- Wipe down the surface of the ventilator housing regularly to remove any dust that might accumulate.

If service is required, contact your provider.

12.2.2 O₂ Sensor Maintenance

It is recommended to replace the internal O₂ sensor once a year. Refer to the Service Manual for details. If the monitored FiO₂ value is different than the set FiO₂ by 8[FiO₂%], O₂ sensor calibration is required and should be performed by a certified FLIGHT-60 technician.

12.2.3 Internal Battery Maintenance

It is recommended that if the batteries are no longer meeting the time requirements of the user, they should be replaced.

→ *To preserve the internal batteries' life:*

- Whenever possible, plug the FLIGHT-60 Ventilator into the external power source to charge the batteries.
- Use the Auto Lighter Cable accessory to power the FLIGHT-60 Ventilator when traveling by automobile.

12.2.4 25,000 Hour Maintenance

A comprehensive maintenance should be performed after 25,000 hours or 5 years of operation, whichever comes first. The 25,000 hour maintenance includes replacement of the blower.

Contact your provider or FLIGHT MEDICAL for detailed information on the 25,000 hour maintenance (see Section 13 for contact information).



HOME CAREGIVERS: Do not attempt to open or perform any service procedures on the FLIGHT-60 Ventilator. Only FLIGHT MEDICAL trained technicians are authorized to service the ventilator. Contact your Homecare Dealer or FLIGHT MEDICAL.

12.3 General Warnings

- Preventive maintenance work, repairs, and service may only be performed by FLIGHT MEDICAL trained or factory-authorized personnel.
- Always follow accepted hospital procedures or physician instructions for handling equipment contaminated with body fluids.
- The ventilator and its accessories must be thoroughly cleaned and disinfected after each patient use. Perform all cleaning and disinfection of external parts and accessories in accordance with

established hospital procedures, physician prescription, or Homecare Dealer instructions.

- Certain components of the ventilator, such as the exhalation valve and the front panel, consist of materials that are sensitive to some organic solvents used for cleaning and disinfection (such as phenols, halogen releasing compounds, oxygen releasing compounds, and strong organic acids). Exposure to such substances may cause damage that is not immediately recognizable.
- The reusable (single patient) patient circuit including the exhalation valve and flow sensing kit and other parts that come in direct contact with the patient should be periodically disinfected while in use.

13 Troubleshooting

13.1 Introduction

The FLIGHT-60 Ventilator is used in life-support situations. As such, it is essential that all individuals using the FLIGHT-60 Ventilator, including clinicians and support staff, have a thorough understanding of its operation. This should include a working knowledge of the ventilator's pneumatic and electronic systems.

The following practical troubleshooting section is provided as a training resource for individuals learning how to use the FLIGHT-60 Ventilator, and as a reference tool for those already familiar with its use and operation. It should be noted that this outline is not all inclusive, and is intended only as a guide.



HOME CAREGIVERS: Contact your Homecare Dealer, physician, or FLIGHT MEDICAL if you have questions or concerns about the performance of the FLIGHT-60 Ventilator.



Only properly trained personnel should operate the ventilator. The FLIGHT-60 Ventilator is a restricted medical device designed for use by Respiratory Therapists or other properly trained and qualified personnel under the direction of a physician and in accordance with applicable state laws and regulations.

13.2 Alarms

Problem	Potential Cause	Suggested Action
Apnea Alarm	Patient did not trigger a breath for the preset Apnea interval (10 to 60 seconds).	Reevaluate the patient and ventilator settings and provide increased ventilatory support, as needed.
	Patient efforts are not detected. Trigger level set improperly.	Use P _{trig} or F _{trig} to adjust the trigger level closer to the baseline pressure (0 cmH ₂ O) so that patient efforts are detected (indicated by the TRIG LED illuminating green).

Problem	Potential Cause	Suggested Action
Prox. Line Alarm	Humidity in the proximal line.	The ventilator purges every 5 minutes, to clean the tubes. Verify the alarm ceased after the ventilator purge.
	Proximal line disconnected or kinked.	Reconnect the proximal line or unkink the line.
	Circuit is disconnected from the patient.	Reconnect the circuit to the patient.
	Quick connector is loosened.	Secure the quick connector.
	Pressure transducer is improperly calibrated or defective.	Call FLIGHT MEDICAL.
Empty Battery Alarm	Detachable and Integral batteries charge is depleted and the ventilator shutdown will occur shortly.	Immediately connect the FLIGHT-60 Ventilator to external AC or DC power.
Power Switch Over Caution	External power cord is disconnected.	Reinsert the power cord.
	External power source failure.	Use the batteries. Recharge the batteries when AC is available.
High Pressure Alarm	Increased patient resistance or decreased patient compliance.	Evaluate the patient. The patient may need suctioning, aerosol therapy, etc.
	Increased patient circuit resistance.	Check for obstructions (kinked tubes, water in tubing, occluded filters, etc.)
	Control/alarm parameters have changed.	Reevaluate settings.
	High Pressure alarm set incorrectly.	Readjust High Pressure alarm, if appropriate. Notify physician as necessary.
High Pbase alarm	Airway pressure remains above the Low Pressure alarm setting at the beginning of inspiration. Indicates an occlusion in the circuit/exhalation valve or that the proximal pressure line or exhalation drive line is pinched.	Unblock the occluded area. Recalibrate the exhalation valve.
	High breath rate (insufficient time to exhale).	Evaluate patient and make necessary adjustments to ventilation parameters.

Problem	Potential Cause	Suggested Action
	Ventilator auto triggering from leak or improper trigger setting.	Fix the leak and readjust trigger level as needed. Change Trigger Mode to Pressure Trigger (Ptrig).
	Rapid decreasing of the PEEP value.	Gradually decrease the PEEP.
High MV alarm	Increased spontaneous patient breathing.	Evaluate the patient. Adjust the High MV alarm setting, if needed.
	Increase in trachea/airway leak.	Evaluate the leak, look for normal wake-sleep trends, and set alarms appropriately.
	Increased minute volume due to ventilator auto triggering from leak.	Check circuit for leak and correct. Perform leak check (exhalation valve calibration) on patient circuit.
	Increased minute volume due to ventilator auto triggering from Ptrig or Ftrig setting too low (most common with single use exhalation valve).	Reevaluate/readjust trigger setting (especially after circuit change).
	Increased minute volume due to ventilator auto triggering from loose quick connector.	Secure the quick connector.
	Increased minute volume due to ventilator auto triggering from circuit disconnected for airway care or by accident.	Reconnect the circuit securely. Push Mute when reconnecting after airway care (to allow one minute for stabilization).
Low Battery Caution	When the combined charge of both batteries is less than 30%.	Plug the power cord into an external power source to charge.
Low Pressure Alarm	Decreased patient resistance or increased patient compliance.	Evaluate the patient. Adjust the ventilation settings and/or Low Pressure alarm, as needed.
	Leak or disconnect in the patient circuit.	Verify that connections are tight and leak free.
	Low Pressure alarm set incorrectly.	Readjust Low Pressure alarm, if appropriate. Notify physician as necessary.
Low Pbase Alarm	Baseline pressure is below set PEEP due to airway or circuit leak, or fluid pooled in tubing.	Verify that all circuit connections are secure and leak free, and that all fluid is cleared from the tubing.

Problem	Potential Cause	Suggested Action
	False Low Pbase Alarm during purge.	Verify the alarm ceased after the ventilator purge. A minor Ti settings change may eliminate this alarm.
Low MV Alarm/Apnea Alarm	Patient efforts are not detected. The trigger level (Ptrig or Ftrig) is set improperly.	Perform a leak check on the patient circuit (exhalation valve calibration), secure the circuit connections, and evaluate the trigger setting. Detected patient efforts are indicated by the TRIG LED illuminating green.
	The Low MV alarm is set above the delivered mandatory minute volume.	Readjust Low MV alarm setting level.
	Patient needs suctioning or airway occlusion (pressure control / pressure support).	Suction and evaluate patient.
	Patient is breathing slowly or is not breathing.	Evaluate patient.
	Apnea interval is too short.	Evaluate the patient. Adjust the Apnea alarm.
	Nebulizer treatment inline during pressure control / pressure support.	Adjust the Low MV alarm during nebulizer treatment.
Occlusion Alarm	Exhalation valve is blocked or line is kinked.	Check the exhalation valve line. Replace the exhalation valve assembly. Then, recalibrate the exhalation valve.
	High breath rate.	Change to lower rate, evaluate patient.
PCV Not Reached Alarm	Gross leak in the patient circuit.	Check all patient circuit connections.
	Target pressure setting requires a flow rate that is beyond the FLIGHT-60 Ventilator's maximal flow capability.	Reevaluate the ventilator settings and strategy.
Fault Alarm Led	Unrecoverable internal system failure.	Ventilate the patient with an alternate means of ventilation. Make note of the message in the alarm display area. Call FLIGHT MEDICAL
Check Setting Alarm	Nonvolatile storage inconsistency.	Verify which ventilation control is out of range and correct its value.
LPV	See section 7.5	See section 7.5

13.3 General/Clinical

Problem	Potential Cause	Suggested Action
Alarm volume too loud or too quiet.	Unintended setting.	To toggle between loud and quiet, push the buzzer button and choose from the list.
Batteries depleted too fast; not lasting up to 8 hours	Batteries are not fully charged.	Charge the batteries to their full charge level. Batteries charge in three hours from AC. Check the charge level by viewing the main and secondary battery icon level on the display. Extend the battery use time by plugging into AC when available. Suggestion: Optional accessory, Automobile 12V power cord can be used to plug the ventilator into the automobile cigarette lighter. Ensure that the green Ext. Power LED is illuminated when connected to an external AC or DC power source (it can take up to one minute). If the LED is not illuminated, check the connections and resolve any problems.
	Power Save is OFF. This decreases battery use time by 20% to 30%.	Enter Extended Setup and turn Power Save ON.
	Batteries are not in optimal condition or need to be replaced.	As the battery ages, the Low Battery caution occurs sooner. When this begins to infringe on the required battery time, the batteries should be replaced.
CO₂ rises Child's CO ₂ rises dramatically when put on the ventilator	Too much dead space (re breathing) in the patient circuit. (On a single-limb circuit, the tubing on the patient side of the exhalation valve is dead space.)	On small patients, avoid using any tubing between the flow orifice and the patient. If extension tubing is a must, it should be as small as 15 mm ID and shorter than 50 mm.
Circuit disconnect / no alarm sounds Patient circuit is disconnected from the patient, but there is no alarm.	Low Pressure alarm is not appropriately set.	Set the Low Pressure alarm to ensure that it sounds when the patient circuit is disconnected. After setting up the patient and stabilizing the ventilation, remove the circuit from the patient at the airway and observe the peak airway pressure that develops with the next breath. Reconnect the patient and set the Low Pressure alarm above this pressure.

Problem	Potential Cause	Suggested Action
	High/Low Minute Volume alarm limits are not appropriately set.	Set High/Low alarms to bracket patient minute volume.
Exhalation Circuit TEST Fails (Cal Failed) Reusable (single patient) or single use exhalation valve	A leak in the system.	a. Check all circuit connections. b. Check that the test lung is leak-free and that it is ≤ 1 L in size. c. Check that the exhalation valve drive line is secured. d. Use your thumb (covered with a clean gauze pad or equivalent) instead of a test lung, to occlude circuit during calibration. e. If using a reusable (single patient) exhalation valve, ensure that the diaphragm is seated properly. f. Try a different exhalation valve. NOTE: After taking corrective action, repeat Exhalation Valve Calibration procedure.
	Exhalation valve in use is not compatible with ventilator.	Use an exhalation valve that is approved for use with the FLIGHT-60 Ventilator.
Exhalation Valve Honks Exhalation valve makes honking noise	Low compliance / high resistance of circuit system. The single use exhalation valve in use is not compatible with the ventilator.	Make sure that the patient circuit is 22 mm ID (regardless of patient size). Use an exhalation valve that is approved for use with the FLIGHT-60 Ventilator.
External Power Not Working After plugging into an external AC or DC outlet, Ext. Power indicator does not light after one minute.	Power cord is not plugged far enough into the ventilator outlet. AC outlet has no power. DC Auto lighter outlet is not active with engine off.	Check that the power cord is pushed in all the way. Check for power in the AC outlet or use another AC outlet with power. Make sure that the auto lighter outlet is active with the engine off, or turn the engine on.
Frequency is 1.5 Times Set Value Ventilator sounds alarm and the respiratory frequency is 1.5 times the original set value.	Ventilator is in Backup Ventilation in response to the Apnea Alarm being violated.	Backup Ventilation will stop, and the respiratory frequency will return to normal when the patient will triggered two spontaneous breaths within the preset Apnea interval or the user press the Alarm Reset button to stop the Backup Ventilation alarm.

Problem	Potential Cause	Suggested Action
Manual Inflation Button Breath terminates and High Pressure alarm is violated.	High Pressure alarm setting reached during Manual inflation.	If a higher inflation pressure is needed, increase the High Pressure alarm limit setting to a safe but appropriate level. Otherwise, decrease the flow rate or manual inflation time.
Manual Inflation Button Cannot generate adequate rise in pressure.	Mandatory flow is set too low.	Evaluate ventilation settings. If appropriate, decrease the inspiratory time to increase the flow.
	Gross leak in patient circuit.	Check/secure all patient circuit connections.
	Faulty exhalation valve.	Replace the exhalation valve.
PEEP Control Baseline pressure during exhalation continues to slowly decrease.	Pressure Control mode.	Assess Pressure Control setting.
	Faulty exhalation valve.	Replace the exhalation valve.
	Leak in the patient circuit.	Perform a leak check (exhalation valve calibration) and eliminate any leaks found.
PEEP Control Monitored Pbase is less than set PEEP.	Leak around ET (Endotracheal) tube/patient interface.	Check ET tube/patient interface.
	Leak in patient circuit, endotracheal tube cuff, patient interface, or other.	Find and correct the leak.
	Un-calibrated exhalation valve.	Calibrate exhalation valve per instructions.
Pressure reading Pressure does not return to zero when PEEP is set to zero.	Faulty exhalation valve.	Replace the exhalation valve.
	Patient circuit resistance is caused by an occluded filter or exhalation valve, pooled water, or lodged secretions which prevent the free exit of patient exhalation.	Temporarily disconnect the patient circuit from the ventilator GAS OUTPUT outlet. If the pressure reading returns to zero, the cause of the elevated baseline pressure is circuit resistance.
		Check for (and empty) water in the patient circuit.
Check for (and replace) the clogged filter or heat moisture exchanger in the patient circuit.		
Water in patient circuit tubing.	Check for (and clean) an exhalation valve that has become clogged with medications or patient secretions.	
	Ensure that the expiratory drive line is not kinked.	
	Drain tubing.	

Problem	Potential Cause	Suggested Action
Pressure reading Baseline pressure (PEEP) is fluctuating.	Leak in patient circuit.	Perform exhalation valve calibration, check/eliminate any leaks found.
	Leak in the exhalation valve.	Replace the exhalation valve.
	Bounce/rebound from test lung.	Use a test lung with better physiological performance.
Pressure Not Rising Ventilator sounds like it is delivering breaths; however, the pressure is not rising during the breath.	Massive leak in the patient circuit.	Locate the leak and fix it.
	Exhalation valve diaphragm has become unseated.	Replace the exhalation valve / patient circuit.
Trigger Problem Patient cannot trigger the ventilator.	Inappropriate trigger setting.	Adjust the P _{trig} /F _{trig} towards "-0.1"/"1" until the ventilator auto-triggers, then slowly increase the P _{trig} or F _{trig} setting until the auto-triggering stops.
	Baseline pressure increased inadvertently due to <i>Rate</i> , <i>Ti</i> , Volume control, or Pressure control change.	Check the ventilation settings; readjust if necessary.
	Baseline pressure increased inadvertently due to incomplete exhalation.	Check the ventilation settings; readjust if necessary.
	Patient lacks any spontaneous effort or has very weak effort.	Evaluate the patient.
Trigger Problem Ventilator auto-triggering	Trigger level is not set properly.	Readjust P _{trig} or F _{trig} level.
	Leak in patient circuit, exhalation valve, or expiratory drive line.	Check/secure the circuit connections. Change the exhalation valve.
Trigger Problem Patient double-triggers the ventilator.	In volume control, the flow is set inappropriately low.	Check the flow setting in the display. If it is too low for patient need, decrease the inspiratory time (<i>Ti</i>) setting until the flow is set appropriately.
	Pressure support is set too low for patient need.	Reevaluate the pressure support setting.
Monitored Tidal Volume V _{te} and V _{ti} inconsistent	Circuit disconnect	Check Circuit Connections
	Quick Connect not firmly attached	Re-attach the Quick Connector

Problem	Potential Cause	Suggested Action
Ventilator Makes Noise When Air/Oxygen Mixer Is Connected.	Cylinder is turned off or empty.	Check that the cylinder is turned on and that it is not empty.
<p>FLIGHT-60 Ventilator makes a loud noise when using the Air Oxygen Entrainment Mixer connected to a gas cylinder.</p>		
Ventilator Pistons Move Between Breaths Ventilator sounds like the dual micro pistons continue to move between breaths.	The FLIGHT-60 Ventilator generates a 7.5 L/min of continuous flow in between breaths when PEEP is > 0 cmH ₂ O.	Ventilator is operating correctly.
Water in Breathing Circuit Tubing	Room temperature is cooler than the heated, humidified breathing gas in the circuit. When the gas in the circuit cools, water precipitates out.	<p>a. Place water trap in line with the patient circuit and empty it regularly.</p> <p>c. Use a heated wire circuit.</p>

13.4 Oxygen Enrichment

Problem	Potential Cause	Suggested Action
Monitored FiO ₂ is less than 21%	Oxygen Sensor Expired	Replace the oxygen sensor
	Non calibrated oxygen sensor	Calibrate oxygen sensor
Monitored FiO ₂ is lower or higher by 5% than the set %O ₂ , when using internal O ₂ mixer.	Oxygen Sensor Expired	Replace the oxygen sensor
	Non calibrated oxygen sensor	Calibrate oxygen sensor
	Oxygen source gas pressure is low	Check O ₂ supply
	Oxygen source gas concentration is less than 100%	Check O ₂ supply
	Low flow O ₂ port connector is connected	Disconnect O ₂ port connector

Problem	Potential Cause	Suggested Action
Mixer makes a pronounced clicking sound during normal operation.	Mixer diaphragm is leaking.	Contact your provider or FLIGHT MEDICAL.
Oxygen leaks out of Mixer when connected to 50 psig oxygen gas source.		

14 Contact Information

Address further questions or problems to one of the FLIGHT MEDICAL offices.

FLIGHT MEDICAL INNOVATIONS Ltd.

Address: 7 Hatnufa St., Petach Tikva 4951025, ISRAEL

Tel: +972-3-673-1660

Fax: +972-3-673-1690

Email: info@flight-medical.com

Website: www.flight-medical.com

European Authorized Representative

Obeliss.a

Address: Boulevard Général Wahis 53 1030 Brussels, BELGIUM

Tel: +32 2 7325954

Fax: +32 2 7326003

Email: mail@obelis.net

15 Ventilator Quick Check Procedure

15.1 Introduction

Upon initial setup of the ventilator, verify proper ventilator operation by performing the Quick Check Procedure.

This procedure is intended to assist qualified operators to establish a routine program for verifying proper FLIGHT-60 Ventilator operation. Perform this procedure each time the ventilator is prepared for clinical use.

Repeat the Quick Check Procedure each time the ventilator is placed on a new patient or the patient circuit/exhalation valve is changed.

Before performing the test, you must perform a pretest inspection, and set up the ventilator for the test.

The Quick Check Procedure includes the following tests:

- Checking the power management
- Checking the alarms
- Checking the monitored parameters



HOME CAREGIVERS: This procedure should be performed by your Homecare equipment provider, prior to delivery of the FLIGHT-60 Ventilator, to verify proper operation. It can also be performed in the homecare environment to ensure proper setup and function of the ventilator.



Do not use the FLIGHT-60 Ventilator if it fails this procedure.

15.1.1 Setting Up the Ventilator for the Test

Before performing the test, do the following:

- Remove the three screws from the Filter Cover. Inspect the filter. Replace the filter if it is dirty. Reinstall the screws.
- Examine the 500 ml test lung and the patient circuit to ensure that there are no holes that will cause leaks.
- Verify that the AC power cord does not have frays or breaks.

➔ *To set up the ventilator for the test:*

1. Connect the detachable and integral batteries.
2. Connect the AC power cord to an AC power source.

3. Connect a patient circuit with 500 ml test lung, to the FLIGHT-60 Ventilator.
4. Calibrate the exhalation valve. See Section 4.7.
5. Press the On/Off button once. The ventilator performs a brief self-test and enters SETTINGS mode. During the self-test, verify that the ventilator purges, an audible alarm sounds and that all indicator LEDs illuminate.
6. Set the ventilator to the following Standard Test Settings (STS):

Control	Setting
MODE	ACMV
Volume Control	500 ml
Ti	1.0 sec
Rate	15 b/min
P _{trig}	-0.1 cmH ₂ O/mbar
Low Pressure alarm limit	3 cmH ₂ O/mbar
High Pressure alarm limit	99 cmH ₂ O/mbar
Low MV alarm limit	0.1 L (minimum setting)
High MV alarm limit	50 L (maximum setting)
PEEP	0 cmH ₂ O/mbar
PS above peep	0 cmH ₂ O/mbar
Waveform	Square

7. Press the On/Off button to initiate ventilation.

15.2 Quick Check Procedure

15.2.1 Checking the Power Management

➔ *To check for power management:*

1. Disconnect the AC power cord. Verify that there is a Power Switchover caution message and intermittent audible caution.
2. Verify the EXT PWR indicator LED turns off, and the BAT indicator turns on to indicate that the ventilator is on battery power.
3. Verify that the arrows on the batteries icons facing down to indicate that the batteries are depleted.
4. Disconnect the detachable battery. Verify that there is a Low Battery caution message and intermittent audible caution.
5. Reconnect the detachable battery and the AC power.
6. Verify the EXT PWR indicator LED turns on, and the BAT indicator turns off.
7. Verify that the arrows on the batteries icons facing up to indicate that the batteries are charged.

15.2.2 Checking the Alarms

➔ *To check for High Pressure alarm:*

1. Set the High P alarm limit to 10 cmH₂O.
2. Verify that High Pressure alarm is activated (HIGH PRESSURE message display, visual and audible alarm and the indicator LED turns on).
3. Verify that inspiration ends when pressure reaches the high limit.
4. Set the High P alarm limit back to 99 cmH₂O.
5. Verify that High Pressure alarm is deactivated.
6. Press the Alarm Reset button to clear the lit indicator LED.

➔ *To check for Low Pressure alarm:*

1. Disconnect the test lung from the patient circuit.
2. Verify that the Low Pressure alarm is activated within 3 breaths. (LOW PRESSURE message display, visual and audible alarm and the indicator LED turns on).
3. Reconnect the test lung to the patient circuit.
4. Verify that the Low Pressure alarm is deactivated.
5. Press the Alarm Reset button to clear the lit indicator LED.

15.2.3 Checking the Monitored Parameters

➔ *To check for pressure reading:*

1. Verify that both the P_{peak} and the pressure gauge are within 10% or $\pm 2_2$ O of each other, whichever is greater.
2. Set the PEEP to 5 cmH₂O.
3. Verify that both the P_{base} and the pressure gauge are within $\pm 2_2$ O of each other. Reduce the PEEP to zero.

➔ *To check for volume reading:*

1. Verify that V_{ti} and V_{te} are within 0.45 to 0.55 L.
2. Verify that M_{Vi} and M_{Ve} are within 6.5 to 8.5 L.

15.3 Check-Off Sheet

FLIGHT-60 Ventilator Quick Check	
Pass/Fail Check-Off Sheet	
Preparation for Use Tests	Indicate Result for each Test
Pretest Inspection Check	Pass _____ Fail _____
1. Power Management Check	Pass _____ Fail _____
Power Switchover Caution	Pass _____ Fail _____
Low Battery Caution	Pass _____ Fail _____
2. Alarms& Indicators Check	Pass _____ Fail _____
High Pressure Alarm	Pass _____ Fail _____
Low Pressure Alarm	Pass _____ Fail _____
3. Monitored Parameters Check	Pass _____ Fail _____
Peak Pressure	Pass _____ Fail _____
Base Pressure	Pass _____ Fail _____
Tidal Volume	Pass _____ Fail _____
Minute Volume	Pass _____ Fail _____
The ventilator is ready for operation when all tests have been completed successfully.	

16 Technical Specifications

16.1 Physical Specifications

Physical Characteristic	Specification
Ventilator Weight	5.5Kg/6 Kg (with internal blender)
Ventilator Dimensions	11.641 in wide x 11.457/13.071 in deep (SL/DL) x 9.803 in high. 295 mm wide x 291/332 mm deep (SL/DL) x 249 mm high.
Reusable Single Patient Circuit	Reusable (single patient) 22 mm ID 180 cm. length adult, 15 mm ID 180 pediatric circuit with 2.75 mm ID proximal pressure sensing line, 2.75 mm ID exhalation valve control drive line, 2.75 mm I.D. flow sensing line, exhalation valve, flow sensing orifice and quick connector.
Single Use Patient Circuit	Single use 22 mm ID 180 cm. length adult, 15 mm ID 180 pediatric circuit with 2.75 mm ID proximal pressure sensing line, 2.75 mm ID exhalation valve control drive line, 2.75 mm I.D. flow sensing line, exhalation valve, flow sensing orifice and quick connector.
Connectors	Gas Outlet: ISO 22 mm OD conical. Air/Oxygen Inlet: ISO 30 mm female fitting.

16.2 Pneumatic Specifications

Item	Specification
Over Pressure Relief Valve	Limits the maximum airway pressure to 110 ± 5 CMH ₂ O
Negative Pressure Relief Valve(Anti-Asphyxia)	Opening pressure is between -3 CMH ₂ O to -6 CMH ₂ O.
O ₂ sensor	MAX 16 by MAXTEC / Analytical Industries model PSR-11-917-MHT; range from 0 to 100% oxygen. Warm up time: less than 30 minutes after replacement.

16.3 Electromagnetic Emission - Guidance and Manufacturer's Declaration

This device is intended for use in the electromagnetic environment specified below. The user of this device should make sure it is used in such an environment.

Emission Test	Compliance	Electromagnetic Environment-Guidance
RF emissions CISPR 11	Group 1	The device uses RF energy only for its internal function. Therefore, its RF emissions are very low and are not likely to cause any interference in nearby electronic equipment.
RF emissions CISPR 11	Class B	The device is suitable for use in all establishments, including domestic establishment and those directly connected to the public low-voltage power supply network that supplies building used for domestic purpose.
Harmonic emissions IEC 61000-3-2	Class B	
Voltage fluctuations/Flicker emissions IEC 61000-3-3	Complies	

Immunity test	IEC60601 Test level	Compliance Level	Electromagnetic Environment Guidance
Electromagnetic Discharge (ESD) IEC 61000-4-2	8 kV contact 2, 4, 8, 15kV air	8 kV contact 2, 4, 8, 15kV air	Floors should be wood, concrete or ceramic tile. If floors are covered with synthetic material, the relative humidity should be at least 30%.
Electrical fast Transient/burst	±2 kV for power supply lines	±2 kV for supply main	Main power quality should be that of a

IEC 61000-4-4	±1 kV for input-output lines	±1 kV for input/output lines	typical home or hospital environment
Surge IEC 61000-4-5	±1 kV differential mode ±2 kV common mode	±1 kV differential mode ±2 kV common mode	Main power quality should be that of a typical home or hospital environment
Voltage dips, short interruptions and voltage variations on power supply input lines IEC 61000-4-11	0% UT; 0.5cycle at 0°, 45°, 90°, 135°,180°, 225°, 270° and 315° 0% UT; 1cycle and 70% UT; 25/30 cycles Single phase at 0° 0% UT; 250/300 cycle	0% UT; 0.5cycle at 0°, 45°, 90°, 135°,180°, 225°, 270° and 315° 0% UT; 1cycle and 70% UT; 25/30 cycles Single phase at 0° 0% UT; 250/300 cycle	Mains power quality should be that of a typical commercial or hospital environment. If the user of the [Flight F60 (V100 Series)] requires continued operation during power mains interruptions, it is recommended that the [Flight F60 (V100 Series)] be powered from an uninterruptible power supply or a battery
Power frequency (50/60 Hz) magnetic field IEC 61000-4-8	30 A/m	30 A/m	Power frequency magnetic fields should be at levels characteristic of a typical home or hospital environment.
Note: U_T is the a.c. mains voltage prior to application of the test level.			

Immunity test	IEC60601 Test level	Compliance Level	Electromagnetic Environment Guidance
			Portable and mobile RF communications equipment should be used no closer to any part of the device, including cables, than the recommended separation distance calculated from the equation applicable to the frequency of the transmitter. Recommended separation distance:

<p>Conducted RF IEC 61000-4-6</p>	<p>3 Vrms 150 kHz to 80 MHz Outside ISM bands¹</p> <p>10 Vrms 150 kHz to 80 MHz in ISM bands²</p>	<p>3V</p> <p>10V</p>	<p>$d = 1.2 \sqrt{P}$</p> <p>$d = 1.2 \sqrt{P}$</p>
<p>Radiated RF IEC 61000-4-3</p>	<p>30V/m 80 to 400 MHz NOTE: based on ISO 10651-3:1997 testing</p>	<p>30V/m 80 to 400 MHz NOTE: based on ISO 10651-3:1997 testing</p> <p>150V/m .4 to 8GHz NOTE: Based on RTCA DO-160F, section 20, cat.R</p>	<p>$d = 0.4 \sqrt{P}$ for 80 MHz to 400 MHz $d = 0.08 \sqrt{P}$ for 400 MHz to 800 MHz $d = 0.15 \sqrt{P}$ for 800 MHz to 8 GHz</p> <p>where P_p is the maximum output power rating of the transmitted in watts (W) according to the transmitter manufacturer and d is the recommended separation distance in meters (m)</p> <p>Field strengths from fixed RF transmitters, as determined by an electromagnetic site survey¹, should be less than the compliance level in each frequency range².</p> <p>Interference may occur in the vicinity of equipment marked with the following symbol:</p> 
<p>NOTE A: At 80 MHz, 400 MHz, and 800 MHz, the higher frequency range applies.</p> <p>NOTE B: These guidelines may not apply in all situations. Electromagnetic propagation is affected by absorption and reflection from structure, object, and people.</p> <p>¹ Field strength from fixed transmitters, such as base stations for radio (cellular/cordless) telephones and land mobile radios, amateur radio, AM and FM radio broadcast and TV broadcast cannot be predicted theoretically with accuracy. To assess the electromagnetic environment due to fixed RF transmitters, an electromagnetic site survey should be considered. If the measured field strength in the location in which the device is used exceeds the applicable RF compliance level above, the device should be observed to</p>			

verify normal operation. If an abnormal performance is observed, additional measure may be necessary, such as re-orienting or relocating the device.

² Over the frequency range 150 kHz to 80 MHz, the field strength should be less than 3 V/m.

Test specifications for ENCLOSURE PORT IMMUNITY to RF wireless communications equipment							
Test frequency (MHz)	Band ^{a)} (MHz)	Service ^{a)}	Modulation ^{b)}	Maximum power (W)	Distance (m)	IMMUNITY TEST LEVEL (V/m)	Compliance level (V/m)
385	380 – 390	TETRA 400	Pulse modulation ^{b)} 18 Hz	1.8	0.3	27	27
450	430 – 470	GMRS 460, FRS 460	FM ^{c)} ± 5 kHz deviation 1 kHz sine	2	0.3	28	28
710 745 780	704 – 787	LTE Band 13, 17	Pulse modulation ^{b)} 217 Hz	0.2	0.3	9	9
810 870 930	800 – 960	GSM 800/900, TETRA 800, iDEN 820, CDMA 850, LTE Band 5	Pulse modulation ^{b)} 18 Hz	2	0.3	28	28
1720 1845 1970	1 700 – 1 990	GSM 1800; CDMA 1900; GSM 1900; DECT; LTE Band 1, 3, 4, 25; UMTS	Pulse modulation ^{b)} 217 Hz	2	0.3	28	28
2450	2 400 – 2 570	Bluetooth, WLAN, 802.11 b/g/n,	Pulse modulation ^{b)} 217 Hz	2	0.3	28	28

		RFID 2450, LTE Band 7					
5240	5 100	WLAN	Pulse modulation ^{b)}	0.2	0.3	9	9
5500	–	802.11					
5785	5 800	a/n	217 Hz				
NOTE: If necessary to achieve the IMMUNITY TEST LEVEL, the distance between the transmitting antenna and the ME EQUIPMENT or ME SYSTEM may be reduced to 1 m. The 1 m test distance is permitted by IEC 61000-4-3.							
^{a)} For some services, only the uplink frequencies are included. ^{b)} The carrier shall be modulated using a 50 % duty cycle square wave signal. ^{c)} As an alternative to FM modulation, 50 % pulse modulation at 18 Hz may be used because while it does not represent actual modulation, it would be worst case.							

16.3.1 Recommended separation distance between portable Mobile RF communications Equipment and the device

The device is intended for use in an electromagnetic environment in which radiated RF disturbances are controlled. The customer or the user of the device can help prevent electromagnetic interference by maintaining a minimum distance between portable and mobile RF communications equipment (transmitters) and the device as recommended below, according to the maximum output power of the communications equipment.

Rated maximum output power of transmitter W	Separation distance according to frequency of transmitter (m)			
	150 kHz to 80 MHz $d = 1.2\sqrt{P}$	80 MHz to 400 MHz $d = 0.04\sqrt{P}$	400 MHz to 800 MHz $d = 0.08\sqrt{P}$	800 MHz to 8GHz $d = 0.15\sqrt{P}$
0.01	0.12	0.04	0.01	0.02
0.1	0.38	0.13	0.03	0.05
1	1.2	0.40	0.08	0.15
10	3.8	1.3	0.25	0.47
100	12	4.0	0.80	1.5
For transmitters rated at a maximum output power not listed above, the recommended separation distance d in meters (m) can be estimated using the equation applicable to the frequency of the transmitter, where P is the maximum output power rating of the transmitter in watts (w) according to the transmitter manufacturer. NOTE 1 At 80 MHz, 400 MHz, and 800 MHz, the separation distance for the higher frequency range applies. NOTE 2 These guidelines may not apply in all situations. Electromagnetic				

propagation is affected by absorption and reflection from structures, objects and people.

16.3.2 Recommended Separation Distances Between Power Buses and the Product

Adjacent Power Bus Current (A)	Separation Distance (m)	Notes
1	0.0053	Using equation $d = \frac{l}{188}$ for compliance level of 30A/m
10	0.053	
100	0.53	
1000	5.3	

16.3.3 EMC statement of Essential Performance

This statement is the basis of the immunity pass/fail criteria for the EMC tests.

The essential performance is:

1. There will be no cessation of ventilation
2. There will be no interruption of power supply

Cables

The AC cable maximum length should be 3 meters.



- ➔ The device should not be used adjacent to or stacked with other equipment. If adjacent or stacked use is necessary, the device should be observed to verify normal operation in the configuration in which it will be used
- ➔ Use of accessories, transducers and cables other than those specified or provided by the manufacturer of this equipment could result in increased electromagnetic emissions or decreased electromagnetic immunity of this equipment and result in improper operation.
- ➔ The ventilator may activate an alarm while in close proximity to a strong 94-100 MHz radiating source. In such case the ventilator should be kept afar from the radiating source until the alarm is deactivated. Special care should be given while the alarm is

activated in order to insure operators are alerted to other alarms, if occur, at the same time

EMC general

1. Medical electrical equipment needs special precautions regarding electromagnetic compatibility (EMC) and needs to be installed and put into service according to the EMC information provided in the Instruction Manual.
2. Portable RF communications equipment (including peripherals such as antenna cables and external antennas) should be used no closer than 30 cm (12 inches) to any part of the [Flight F60 (V100 Series)] including cables specified by the manufacturer. Otherwise, degradation of the performance of this equipment could result.”

16.4 Electrical Specifications

Voltage	Frequency	Current Consumption
100 – 240 VAC	50 – 60 Hz	1.25 Amp MAX
12.5 – 15 VDC	NA	8.0 Amp MAX

16.5 Internal Battery Specifications

Battery Characteristic	Specification
Detachable Battery	
Battery Type	Li-Ion
Nominal Voltage	14.8 VDC
Nominal Pack Capacity	5.2 AH
Charging Time	Three hours MAX
Integral Battery	
Battery Type	Li-Ion
Nominal Voltage	14.8 VDC
Nominal Pack Capacity	2.6 AH
Charging Time	Three hours MAX

Average operating time for both batteries working together: When new and fully charged, the batteries supply power for up to 8 hours of operation at these settings: ACMV mode, Rate=15, Volume Control=500 ml, Ti=1.0 sec, PEEP=0, Max. Airway pressure = 30 cmH₂O/mbar, Power Save mode ON.

16.6 Safety and Particular Standard Specifications

Standard	Specification
IEC 60601-1	Medical electrical equipment general requirements for basic safety and essential performance.
IEC 60601-1-2	General requirements for basic safety and essential performance; Collateral standard: electromagnetic compatibility.
IEC 60601-1-8	Parts 1-8: general requirements for safety; Collateral standard: general requirements, tests, and guidance for alarm systems in medical electrical equipment and medical electrical systems.
ISO 80601-2-12	Particular requirements for the safety of lung ventilators – Critical care ventilators.
ISO 10651-3	Lung ventilators for medical use – Part 3: Particular requirements for emergency and transport ventilators.

16.7 Environmental Specifications

Condition	Range
Operating Temperature	-18 °C to 50 °C / -4 °F to 122 °F
Storage Temperature	-20 °C to 60 °C / -5.8 °F to 160 °F
Operating Pressure (Altitude)	70 KpA to 110 KpA, up to 15,000ft
Humidity	15% to 95% RH at 31 °C
Water Resistance	IP34 (splash proof) IEC 60529
Sinusoidal Vibrations	IEC 60068-2-6
Bump	IEC 68-2-29
Free Fall	IEC 60068-2-32
Random Vibrations Wide Band	IEC 60068-2-6

16.8 Internal O2 Mixer

Feature	Specification
Connector Type	DISS
Input Pressure – Oxygen	35-90 psig/240-620 kPa

Feature	Specification
FiO ₂	21% to 100%
Accuracy	±5%
21% to 90% FiO ₂ Response Time	Up to 20 seconds

16.9 Low Flow Port Oxygen Specifications

Item	Specification
Oxygen Flow	0 to 15 L/min
Oxygen Pressure	Below 50 psig

16.10 Air/Oxygen Entrainment Mixer Specifications

Item	Specification
Oxygen	35 psig to 90 psig (2.4 Bar to 6.2 Bar) full operating range
Air	Atmospheric pressure
FiO ₂ Control	Adjusted continuously from 21% to 100% accuracy ± 8%

16.11 Internal Oxygen Sensor Specifications

Item	Specification
Range of Measurement	0 to 100% Oxygen
90% Response Time	Less than 13 seconds
Accuracy	+/- 2%

16.12 WEEE Disposal Information

EU Waste Electrical and Electronic Equipment (WEEE)

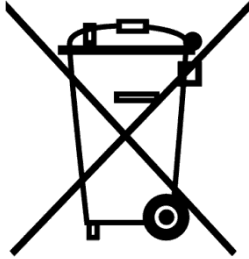

WEEE symbol – crossed out wheeled bin

EU Waste Electrical and Electronic Equipment (WEEE) Directive

In August of 2005, the European Union (EU) implemented the EU WEEE Directive 2002/96/EC and later the WEEE Recast Directive 2012/19/EU requiring Producers of electronic and electrical equipment (EEE) to manage and finance the collection, reuse, recycling and to appropriately treat WEEE that the Producer places on the EU market after August 13, 2005. The goal of this directive is to minimize the volume of electrical and electronic waste disposal and to encourage re-use and recycling at the end of life.

If you have purchased Flight Medical-branded electrical or electronic products in the EU and are intending to discard these products at the end of their useful life, please do not dispose of them with your other household or municipal waste. Flight Medical has labeled its branded electronic products with the WEEE Symbol (see above) to alert our customers that products bearing this label should not be disposed of in a landfill or with municipal or household waste in the EU.

Flight Medical Innovations Ltd. has met its national obligations to the EU WEEE Directive by registering in those countries to which Flight Medical is an importer.

For professional users in the European Union

If you wish to discard electrical and electronic equipment (EEE), please contact your dealer or supplier for further information.

For disposal in countries outside of the European Union

This symbol is only valid in the European Union (EU). If you wish to discard this product please contact your local authorities or dealer and ask for the correct method of disposal

16.13 Technical Description

If required, the following technical description of the F60 can be provided.

1. Summary description of the filtering and/or smoothing techniques for all measured and/or computed variables that are displayed or used for control.
2. Pneumatic diagram of the ventilator, including a diagram for operator-detachable parts of the ventilator breathing system.
3. Summary description of the means of initiating and terminating the inspiratory phase in each mode of the ventilator.
4. Description of a method for checking the function of the alarm system for each of the alarm conditions specified in this standard
5. **Alarm signals validation**

The following procedures can be used to verify the functionality of the Alarm System

1. In order to give rise to **Low priority** alarm signal:
 - a. turn the vent on with AC cable connected
 - b. on standby mode, pull out the AC cable

EXPECTED RESULT	PASS/FAIL
Yellow alarm "Power Switchover" is displayed	
Circular sound sequence – 3 slow notes and long pause	
Visual alarm is ON	
Remote alarm is ON	

2. In order to give rise to **Medium priority** alarm signal:
 - a. Connect the adult simulated lung (C=0.05, R=5), set the STS prescription
 - b. Set Alarms: LOW RATE limit to 20
 - a. Start ventilation

EXPECTED RESULT	PASS/FAIL
Red alarm "Low Rate" is displayed	
Circular sound sequence – 5 fast notes, short pause, 5 fast notes and medium pause	
Visual alarm is blinking	
Remote alarm is ON	

3. In order to give rise to **High priority** alarm signal:
 - a. Connect the adult simulated lung (C=0.05, R=5), set the STS prescription
 - b. Start ventilation
 - c. Disconnect the outlet tube

EXPECTED RESULT	PASS/FAIL
Red Alarm "Check Circuit" is displayed	
Circular sound sequence – 2 fast notes without pause	
Visual alarm is blinking	
Remote alarm is ON	

17 Index

A			
AC connector		3-4	
Accessories		11-1, 12-5	
ACMV		6-6	
ACMV mode		9-1	
Actual f		8-2	
Actual rate		8-1, 8-6	
Air inlet particle filter		12-15	
Air/Oxygen entrainment mixer		4-6, 11-1	
Installing		4-7	
Specifications		16-10	
Air/Oxygen entrainment mixture		13-9	
Airway pressure		8-6	
Alarm connector		3-4	
Alarm Reset button		3-2, 3-3	
Alarm specifications		7-3	
Alarm volume		13-5	
Alarms		7-1	
APNEA		7-3	
Audible Alarms		7-1	
Automatic Technical		7-6	
Automatic Ventilation		7-4, 7-5	
Battery low		7-4	
BUV		7-4	
CHECK CIRCUIT		7-4	
Checking		15-3	
EMPTY BAT		7-4	
FiO2 HIGH		7-3	
FiO2 HIGH		7-3	
HIGH MV EXH		7-3	
HIGH MV INS		7-3	
HIGH PBASE		7-4	
HIGH PRESSURE		7-3	
High Rate		7-3	
LOW MV EXH		7-3	
LOW MV INS		7-3	
LOW PBASE		7-4	
LOW PRESSURE		7-3	
Low Vte		7-3	
Low Vti		7-3	
Main BAT CHARGER		7-5, 7-6	
Main BAT GAUGE		7-6	
Main BAT TEMP HIGH		7-6	
Main BAT V. HIGH		7-5, 7-6	
Main BAT V. LOW		7-5	
Main BAT VOLTAGE		7-6	
MEMORY FAULT		7-5	
MOTOR FAULT		7-5	
OCCLUSION		7-4	
PCV NOT REACHED		7-4	
POWER FAULT		7-5	
PROX LINE		7-4	
Resetting		7-10	
Sec BAT V. HIGH		7-6	
Sec BAT V. LOW		7-6	
Setting remote alarm		7-11	
Silencing		7-10	
Target Volume Not Reached		7-4	
Variable ventilation		7-3	
Visual Alarms		7-2	
Alarms screen		6-10	
Apnea Interval		6-10	
Buzzer		6-10	
FiO2 High		6-11	
FiO2 Low		6-11	
HIGH MV		6-5, 6-10	
HIGH P		6-5, 6-10	
HIGH Rate		6-10	
LOW MV		6-5, 6-10	
LOW P		6-10	
LOW Vte		6-10	
LOW Vti		6-10	
Altitude Compensation		10-8	
Apnea alarm		13-1	
Apnea backup ventilation		7-8	
Apnea Interval		6-10	
APNEA, LED indictator		3-3	
APRV		6-6	
Assist/Control mandatory ventilation		6-6	
Attaching patient circuit		4-3	
Audible Alarms		7-1	
Automatic Technical Alarms		7-6	
Automatic Ventilation Alarms		7-4, 7-5	
B			
Back panel		3-4	
AC connector		3-4	
DC connector		3-4	
Detachable battery		3-4	
Low flow oxygen port		3-5	
Network logging		3-5	
PC connector		3-5	
Peripherals connector		3-5	
Remote alarm connector		3-4	
Uploading log files		3-5	
Backup ventilation		9-2	
ACMV		7-8	
SIMV		7-8	
SPONT		7-8	
Backup ventilation cancellation		7-8, 7-9	
Baseline airway pressure		8-6	
Baseline pressure		6-2	

Lung Mechanics	8-4	Air/Oxygen entrainment mixer	4-6
		Oxygen value	6-11
M		P	
Main BAT CHARGER	7-5, 7-6	P base	8-6
Main BAT GAUGE	7-6	P high	9-10
Main BAT TEMP HIGH	7-6	P High	6-5
Main BAT V. HIGH	7-5, 7-6	P low	9-10
Main BAT V. LOW	7-5	P Low	6-5
Main BAT VOLTAGE	7-6	P mean	8-6
Maintenance		P Peak	8-1, 8-6
15,000 hour	12-19	Panel lock button	3-2
Internal battery	12-18	Parameters button	3-2
O ₂ sensor	12-18	Parameters screen	6-1
Mandatory breath lockout interval	9-2	ACMV	6-6
Mandatory breaths	9-1	FLOW	6-3
Mandatory flow	6-3	Ftrig	6-2
Mandatory tidal volume	6-4, 9-4	PCV above peep	6-4
Maneuvers	6-13	PEEP	6-2
Manual breath button	3-1, 3-2	PSV above peep	6-3
Manual breath, delivering	10-3	PSV max	6-4
Manual inflation button	13-7	PSV min	6-4
MEMORY FAULT	7-5	Ptrig	6-2
Monitored parameters checking	15-3	Rate	6-3
Monitored tidal volume	13-8	SIMV	6-6
Monitoring	8-1	SPONT	6-6
Control values	5-3	Ti 6-4	
PCV submode of operation	9-5, 9-6	VCV	6-4
Target pressure	9-6	Patient circuit	4-3
Target volume	9-4	Cleaning	12-7, 12-9
MOTOR FAULT	7-5	Disassembling	12-6
Mounting ventilator	4-1	Dual limb	4-3
Mute button	3-2	Single limb	4-3
MVe	8-1, 8-2, 8-6	Patient circuit connection	3-1
MVG	9-8	Patient circuit connector	3-1
MVi	8-6	Patient Circuits	12-5
N		PC connector	3-5
Navigating between screens	5-3	PCV	9-2, 9-4, 9-6
Nebulizer	6-6, 10-1	PCV above peep	6-4
Network logging	3-5	PCV not reached alarm	13-4
Next service	6-12	Peak inspiratory flow	8-6
NIV	6-9	Peak inspiratory pressure	8-1, 8-6
Non invasive ventilation	9-10	PEEP	6-2
NPPV	9-10	PEEP control	13-7
Numeric display	8-6	Peripherals connector	3-5
O		Physical specifications	16-1
O₂	6-5, 10-2	PIF	8-6
O ₂ enrichment monitoring	6-11	Plateau Pressure	8-4
O ₂ Leak	7-7	Plugging in power cord	4-2
O ₂ Sensor	6-11	Pneumatic Specifications	16-1
O ₂ sensor maintenance	12-18	Positive airway pressure	6-2
Occlusion alarm	13-4	POWER FAULT	7-5
OK button	3-3	Power management	15-2
On/Off button	3-1, 3-3	Power save	6-12
Orange LED	3-3	Power switch over caution	13-2
Oxygen supply	4-5	Power Switchover	7-6
		Powering on ventilator	5-1
		Preserving internal battery life	12-18
		Preset Ventilation Configurations	10-4

